

**Operator's manual for Pentrunder RS2i wall saw and
Pentpak[®] 3i HFi power pack**

Pentrunder[®]

CONCRETE CUTTING SYSTEMS

Safety icons in this manual

**Note!**

Technical specifics and methods to facilitate the job.

**Important!**

Risks connected with use of the machine. Failure to comply with the safety precautions can result in damage to property and injury to persons in the machine's proximity.

**WARNING!**

Life-threatening dangers connected with use of the machine. Examples of potential injuries given in italic type. Failure to comply with safety precautions can result in serious or fatal injuries to persons in the machine's proximity.

Introduction

Thank you very much for your confidence in our product! You have chosen to invest in a product which will give you many years of efficient and profitable production. The Pentruder RS2i HFi wall saw has been developed based on more than 25 years of experience in this specialized field. The machine is state of the art and follows present regulations. With correct handling it offers outstanding performance, safety, and reliability.

The Pentruder HF-wall saws represent a very modern and safe type of concrete wall saw. It is developed and manufactured by **Tractive AB** in Sweden in a process where safety awareness, performance and reliability are the most important design parameters.

We are confident that your investment in this equipment and its many design features will enhance your competitive edge and profitability!



It is essential that all personnel working with or in the proximity of the machine have read and understood all contents of this manual before commencing operations. Please take careful note of the Safety instructions.

The operator's manual must always be available to the operator of the machine.

To reduce the risk for serious or fatal injuries to the operator and persons in the proximity of the machine, it is an absolute requirement that the machine only is operated by trained, responsible personnel.

Validity

This operator's manual is only valid for the Pentruder RS2i wall saw as described in Chapter 1 Description of the machine.

Tractive AB always strives to improve the products. Therefore, we reserve the right to make technical changes without previous notice.

In this operator's manual, the terms "the machine", "wall saw", "Pentruder HFi wall saw", "Pentruder RS2i" are used to refer to the complete machine as listed in 1. Description of the machine.

Should questions arise, please contact our sales distributor. The address can be found at www.pentruder.com.

Product	Description	Serial number
Category:	Wall Saw	
Make and type:	Pentruder RS2i	_____
Drive system:	Pentpak HFi Power Pack	
Type of drive system:	High frequency drives	_____
Drive motor:	Pentruder high frequency motor	
Type of drive motor:	Permanent magnet motor	_____
Accessories:	As stated in Chapter 1	
Remote control:	Wireless and cable Remote Control	_____

Manufacturer:

Tractive AB
Gjutargatan 54
S-781 70 Borlänge
Sweden

Pentruder Distributor

Phone: +46 (0)243 - 22 11 55

Fax: +46 (0)243 - 22 11 80

E-mail: info@tractive.se

Web: www.tractive.se

Operator's manual for Pentruder RS2i wall saw and Pentpak® 3 HFi power pack



Version: 1.0

Support & Service document

Original instructions



Copyright © 2025 Tractive AB.

Pentruder and Pentpak are registered trademarks belonging to Tractive AB.

Contents

<i>Safety icons in this manual</i>	2
<i>Introduction</i>	2
<i>Validity</i>	3
1 Description	5
1.1 Complete machine	5
1.2 Signs and symbols	6
2 Safety instructions	8
2.1 Intended use	8
2.2 General safety	9
2.3 Preparational safety	9
2.4 Operating safety.....	11
3 Transport, preparations and mounting	12
3.1 Equipment.....	12
3.2 Transport	12
3.3 Mounting of track feet and tracks.....	15
3.4 Mounting the saw head on the track	18
3.5 Mounting of saw blade.....	19
3.6 Mounting the blade guard	23
3.7 Connecting the RS2i to Pentpak 3i	24
3.8 Pentpak 3i, Power pack – connections and functions, input side.....	25
3.9 Radio remote control	27
3.10 Peripheral cutting speed and spindle speeds	30
4 Cutting	31
4.1 Ready to cut?	31
4.2 Special cutting features	34
4.3 When cutting is finished	36
4.4 Storage of the machine	36
5 Trouble shooting and menu functions	37
5.1 Saw blade issues.....	37
5.2 The Pentpak, RRCi or RS2i do not work properly.....	38
5.3 Menu functions	40
6 Maintenance	42
6.1 Every day / week maintenance	42
7 Technical data	45
<i>Declaration of Conformity</i>	47

1 Description

1.1 Complete machine

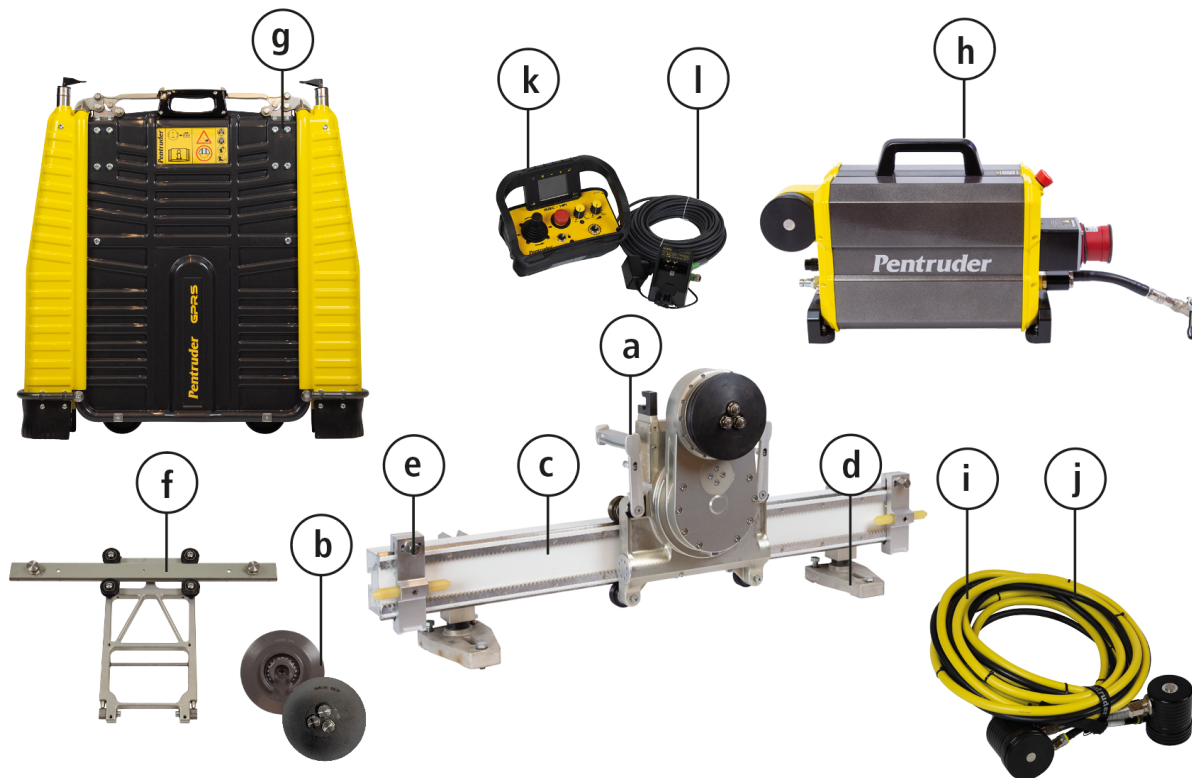

A complete Pentruder RS2i HFi wall saw is comprised of at least:

- a. One Pentruder RS2i saw head
- b. One complete Blade flange
- c. One TS Track
- d. Two TF2S Track feet
- e. Two TP3 track stop
- f. One Blade guard guide
- g. One Blade guard
- h. One Pentpak 3i, HFi power pack
- i. One Machine cable
- j. One Water hose (attached to Machine cable)
- k. One RRCi Remote control
- l. One Operator's manual: Pentruder® RS2i HFi wall saw and Pentpak® 3i HFi power pack (not pictured)











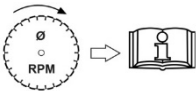

As described in this Operator's manual, and on our website www.pentruder.com. Please note that a Pentruder HFi wall saw is not complete without the modules and accessories listed in this paragraph.

For more accessories, see www.pentruder.com.

1.2 Signs and symbols

For symbols used on the RRCi display, see chapter 4 and 5.

1.2.1 Symbols

	See rpm chart in Operator’s manual to choose correct spindle speed.
	Refer to the Operator’s manual.
	This product is in accordance with applicable EC-directives.
	Warning sign
	The trash bin symbol is an environmental marking and indicates that this machine contains electrical/electronic equipment which should be recycled. Please contact your Pentruder Distributor for more information
	Risk of serious or fatal cut from saw blade. Extreme Danger may occur from concrete chips, reinforcement bar fragments, debris or saw blade diamond segments thrown out from the cut at very high and potentially lethal speed.
	Make sure a blade guard is always fitted_during the cutting process
	High voltage triangle. Warning – danger of life
	Safety helmet, safety glasses and hearing protection should be worn.
	Protective shoes should be worn.
	Protective gloves should be worn.
	An appropriate safety dust mask or adequate respiratory protection should be worn depending on the material cut and the environment.

1.2.2 Signs on the machine



1. Machine sign for RS2i saw head



- a. Serial number of Pentruder RS2i
 - b. Year of Manufacture
 - c. Max blade diameter
 - d. Maximum output power 18 kW
 - e. Connect to 380 – 480 V input power, see chapter 3.8
 - f. Blade speed range is between 500 and 1150 RPM
- Symbols, see 1.2.1

2. Information sign about locking mechanism for blade quick disconnect coupling



See symbols above and chapter 3.5 for instructions.

3. Sign on Track

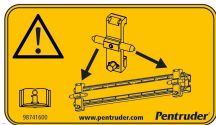

Track stops should be mounted at both ends of the track. See chapter 3.3 for instructions.

4. High voltage warning sign on Pentpak 3i

Symbol, see 1.2.1. See also chapter 2.2 general safety and 3.8 for description

5. Information about radio, and warning sign about high voltage

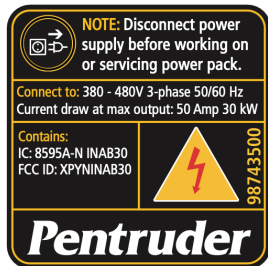

- a. Disconnect power supply before working on or servicing the machine
- b. Connect to 380 – 480V 3-phase 50/60 Hz
- c. Current draw at max output: 50 A, 30 kW
- d. Contains: list of radio modules
- e. Symbols, see 1.2.1

6. Residual Current Circuit Breaker



RCCB Type B: The RCCB is situated under the cover to the right.
 PP3i 400: No built in RCCB, Pentpak 3i, HFi, 380-480V
 PP3i 480: No built in RCCB, Pentpak 3i, HFi, 480V (USA)

7. Machine sign for Pentpak 3i

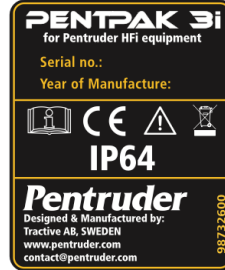

- a. Serial number of Pentpak 3i
 - b. Manufacturing year
- Symbols, see 1.2.1

8. Sign for Green button and Voltage indicator



Symbol for Green button (upper button) and Voltage indicator (lower lamp). See 3.8 for description.

9. Radio remote control (RRCi)

- Radio remote control identification plate
- Transmitting unit identification plate
- Technical data plate

See Plates in the “Instruction Manual for the use and the maintenance of the Radio Remote Control” at Pentruder.com

10. Warning sign, blade guard

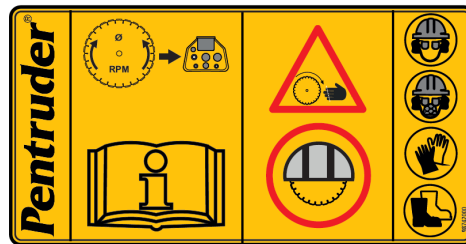

Symbols, see 1.2.1

11. and 12. Signs on trolley



Shows position of Emergency stop on Pentpak 3i



Max permissible total weight 170 kg. Blade guard must be mounted if trolley is loaded with saw blade (see also 3.2). Symbols, see 1.2.1.

13. Receiver for RRCi

- Radio remote control identification plate
- Technical data plate

See Plates in the “Instruction Manual for the use and the maintenance of the Radio Remote Control” at Pentruder.com

2 Safety instructions

2.1 Intended use

See safety icon description on page 2. This wall saw must not be used unless all persons operating, or in any way working on the machine has full knowledge and understanding of the whole Operator's manual and all its safety instructions. They must also have had training in its operation by an authorized distributor of Tractive AB's products. The operator must accept and take full responsibility for the correct operation of the machine. It is the obligation, and responsibility of the employer/purchaser of the machine that the operator has received the information needed to operate and take care of the machine in a safe and correct way.

Good working practice should always be used along with common sense. Tractive cannot foresee every possible situation and this manual is not a substitute for the required professional skills and experience.

All other use than mentioned in this manual is non-intended and therefore forbidden.

- A Pentrunder HFi wall saw must be used together with a Pentpak HFi power pack and cannot and may not be used with any other type of power pack.
- The Pentpak HFi power pack may only be used to power Pentrunder HFi machines.
- The track feet must be mounted on a completely rigid, and stable structure, not on any type of moving or mobile device.
- Always use diamond blades well suited for the power output of the machine. Always follow the diamond blade manufacturer's recommendations. For maximum saw blade specifications, see 7 Technical Data.

The Pentrunder HFi wall saw may only be used for cutting of:

- Concrete
- Stone material
- Masonry

Tractive AB disclaims all responsibility for damages to persons and / or property resulting from use of the machine, whether they are caused by faulty handling or from damages occurring as a consequence of negligent or faulty maintenance, or as a consequence of failure to check and control the machine with regard to damages and / or faults. The described injuries in the warnings are not conclusive but should be considered as examples of what may happen when safety instructions are not followed. Failure to comply may also result in other types of injuries.



WARNING!

Do not use the machine for cutting other materials than listed above. Do not attempt to fix the machine on fragile or loose materials of any kind. The safe fastening of the track feet can only be performed on materials with integrity and strength high enough to securely and positively hold the fastening anchors in place under load, all the way up to their specified load limit. See anchor manufacturers specifications.



Important!

Tractive's responsibility for the product is only accepted when the Pentrunder saw head is used according to instructions, together with power packs and accessories described in this Operator's manual. If the machine is used with non-original replacement parts or any other non-Tractive equipment, Tractive's CE-marking will automatically be rendered void and any warranty will also be void.

2.2 General safety



WARNING - DANGER OF LIFE!

Cutting into an energized power line can make the wall saw and its accessories conductive of high voltage and current which can result in serious or fatal injuries. A circuit breaker cannot protect against this danger.



WARNING!



Failure to understand and comply with the safety instructions in this manual can expose the operator and persons in proximity of the machine to extreme danger and can result in serious or fatal injury.



WARNING!

- The machine may only be operated and serviced by authorised and trained personnel. The personnel must be trained by personnel authorised by Tractive.
- To maintain the warranty and level of safety inherent in the design of this machine, only Tractive original replacement parts may be fitted. Tractive AB disclaims all responsibility for damage occurring as a result of using non-original parts.
- Any kind of modifications or changes on the machine are not allowed.
- The machine may not be used in an environment where explosion protected equipment is demanded.
- Safety and health regulations at the workplace must be followed along with the safety instructions in this manual.
- Never use a diamond tool for materials it is not intended for.
- The user is responsible for and liable that the machine and diamond tools are in faultless condition and all functions in perfect order before work is commenced. Cracked saw blades must never be used.
- Dry cutting without water cooling to the saw blade is prohibited.

2.3 Preparational safety



WARNING!

CAUTION WHILE TRANSPORTING AND LIFTING

Risk of crushing from falling objects.

- Use the lifting handles on the saw head or place it in the transport trolley for safe handling. Make sure the machine modules are secured to the transport trolley and that the transport trolley is placed on a stable, flat surface. If placed on a slope or uneven surface, instability may occur and it can fall or roll away.
- Always lift the machine ergonomically correct and in a safe way.
- Avoid lifting and carrying heavy objects alone and use appropriate lifting equipment when necessary.
- If the machine needs to be lifted with a crane, this can only be done after permission and instructions have been given by a person responsible for safety on the site.
- For lifting and transportation of the machine in the transport trolley, see 3.2.



BEFORE MOUNTING AND USING

Fatal injury may be caused by sudden machine start-up. Risk of electric shock from live cables and connectors. Uncontrolled movements of the saw may result in injury or death.



- Before any kind of service or mounting of, or on the machine is commenced, the Pentpak 3i power pack must always be disconnected from the electric power supply.



WARNING!

If the machine does not stop running after an accident it may result in fatal injury. Uncontrolled movements of the saw may result in injury, death, and material damage. Cutting in a power line may result in serious injury or sudden death.

Before cutting is commenced, make sure:

- There are no power lines, gas pipes or other piping which can be damaged or cut off by the saw blade.
- The statics of the building are not compromised because of the cut openings.
- No damage is done on the other side of the concrete when cutting through.
- You check with a person responsible for site safety that all necessary precautions have been performed before commencing work and await the approval of the safety precautions and mounting position of the machine before work is commenced.
- To not commence any work which cannot be judged safe. Always use common sense and best working practice.
- All persons involved know where the emergency stop button is located and how it works.
- That the emergency stop button can be reached quickly.
- There are always sufficient lighting and visibility.



WARNING!

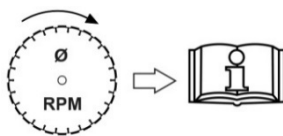

Before cutting is commenced, make sure the saw blade rotational speed is correctly set. Do NOT start at and/or cut at a too high speed. See 3.10 “How to choose correct cutting speed”.



WARNING!

WEAR SAFETY EQUIPMENT

Risk of cut from saw blade, crushing injuries, permanent hearing disorders and chronic respiratory problems. Risk of frostbite in cold temperatures or burn injuries from hot parts.



- All persons working with, or in the proximity of the machine must wear safety equipment, i.e., safety helmet, safety shoes, safety gloves, safety glasses and hearing protection. Note that protective equipment does not provide complete protection from injury. All other safety precautions must also be followed.
- Wear appropriate safety dust mask or adequate respiratory protection depending on the material cut and the environment. Cutting in hazardous material can be very dangerous for operator health and is prohibited without adequate protection.
- The operator may not wear any kind of loose clothing or any object that can be easily trapped. Always follow and respect the construction site safety guide.



WARNING!

WHEN THE MACHINE IS WORKING, THE BLADE GUARD MUST ALWAYS BE FITTED

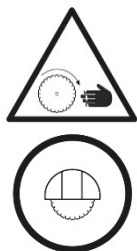

Risk of serious or fatal cut from saw blade. Extreme Danger may occur from concrete chips, reinforcement bar fragments, debris or saw blade diamond segments thrown out from the cut at very high and potentially lethal speed.

- A blade guard must always be fitted during the cutting process.

2.4 Operating safety



WARNING! STAY OUT OF RISK AREA

Risk of serious or fatal cut from saw blade. Risk of being drawn in by rotating and moving parts, getting trapped resulting in cutting and crushing injuries. Danger from concrete chips or other debris or even saw blade segments thrown out from the cut at lethal speed. Uncontrolled movements of the saw may result in injury or death. Risk of crushing from falling concrete blocks or objects. Risk of fire if disconnecting cables while the saw is in operation.

- The operator shall keep a minimum safety margin of 2.0 m to all working and moving parts during the operation. Should the machine fall from the wall or ceiling it could cause severe injuries or death.
- The operator should have perfect vision over the machine.
- The risk area must be roped off and the operator must make sure that no unauthorized person enters the risk area.
- Clear the working area and make sure no persons or objects are within the risk area (see drawing below) before the machine is started.
- To avoid slip and fall accidents, make sure to cover openings immediately after they are cut.
- Do not mount the wall saw onto any object which is not completely rigid and/or securely fixed.
- Cut off concrete blocks must never be allowed to fall without control. If a cut of concrete (or other material) block is allowed to fall without control, this will potentially cause great danger to the operator and any people in the proximity of the machine and damage or destroy the machine and/or the saw blade. If blocks must be allowed to fall, guards must be placed outside the risk area to prevent other people to enter the risk area.
- Always switch off the wall saw before disconnecting or connecting cables.
- The blade does not stop immediately after shutting down the saw. Do not approach the machine before the blade has come to a complete stop.
- Ensure that the system is switched off and cannot be switched on again when leaving it unsupervised, i.e., remove the cable between Pentpak and wall saw.
- If the visibility is not sufficient (for example because of water mist) the machine must be stopped, and the cut area controlled.

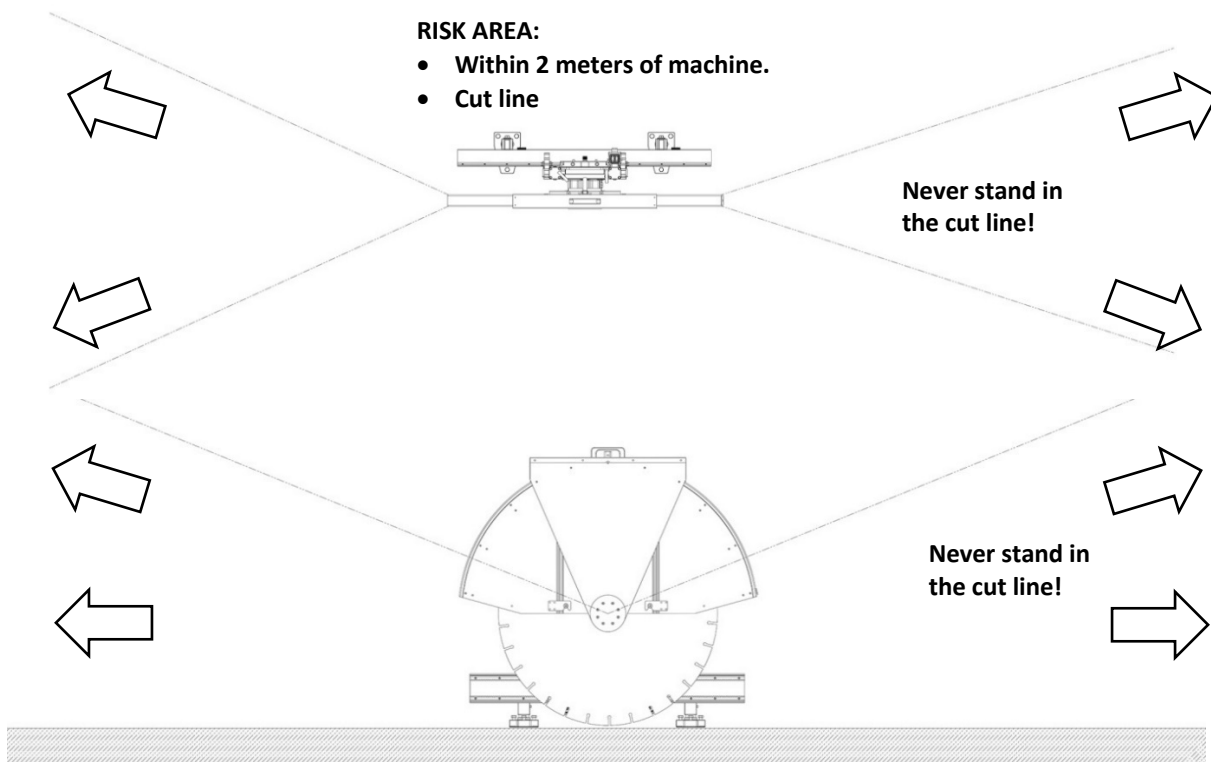



Important!

- The power pack is water cooled and must be drained from water when the ambient temperature is in the proximity of or below 0 degrees Celsius. See Connection to water supply.
- Maximum water pressure during operation is 6 bar.
- The water supply may only be connected to the input side of the Pentpak 3i. The quick disconnect couplings may not be replaced with couplings that are not fully open when disconnected.
- The power pack should only be operated when it is standing on its feet.
- Connect the HFi-power pack only to the Pentruder RS2i HFi-wall saw.

3 Transport, preparations and mounting

3.1 Equipment

In addition to the modules of a complete machine the operator should have the following at hand:

Equipment	Used to
Hammer drill	Drill holes to secure the track feet
Hammer	Secure anchors
Anchors and bolts	Mount the track feet
Tool set for mounting	Mount the wall saw
Pentruder mounting templates	Simplify the positioning of track feet and setup of the Pentruder wall saw
Level	Mount the track correctly at set up.
Set square	Make sure the blade is 90° to the concrete (or at the angle required)
Measuring tape	Position track feet in relation to cut line.
Industrial vacuum cleaner	Collection of concrete slurry and water retention
Securing equipment	Secure the cut concrete slabs
Personal protection equipment. For example: Safety helmet, safety goggles and hearing protection, dust protection in dusty environments, protective clothes, shoes and gloves	Provide personal safety

3.2 Transport

All parts of the complete wall saw can be transported on the transport trolley, with extra space for an up to Ø 800 mm saw blade and optional equipment in the lower tool box. When the transport trolley is used, the Pentpak can preferably stay on the trolley during cutting.

It is recommended to use the transport trolley to transport the machine in an ergonomic and safe way.

See also 4.4 Storage of the machine.

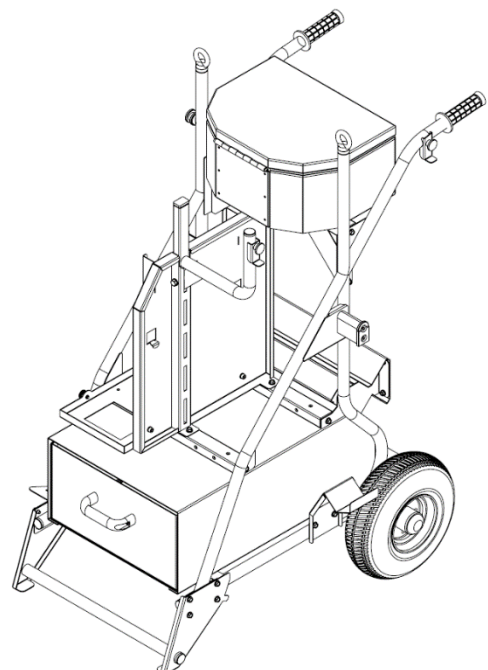

Unloaded transport trolley

3.2.1 Transport trolley

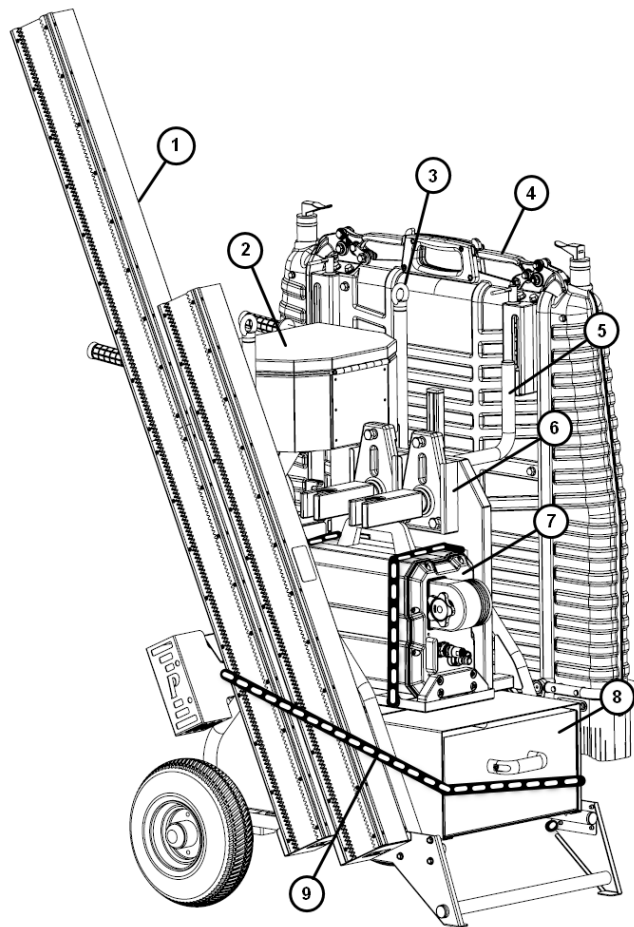

Loaded transport trolley front

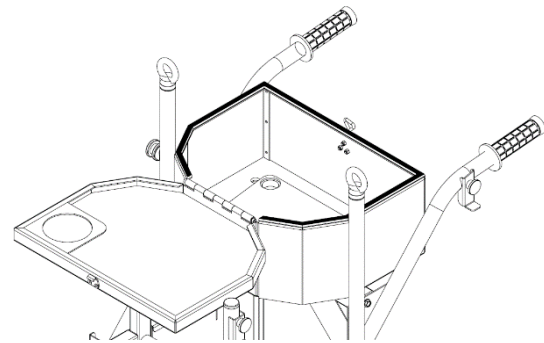

The lid of the remote box may also be opened for extra workspace.

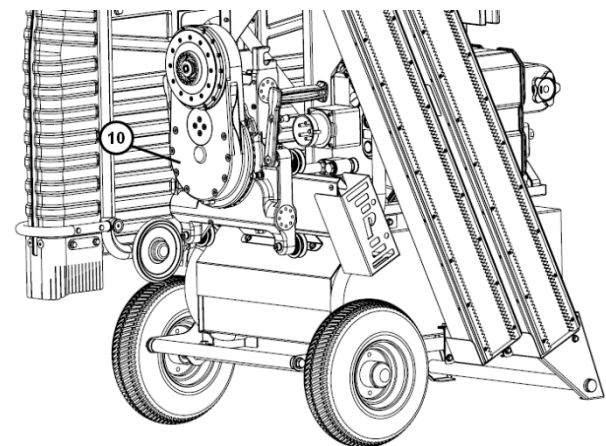

Loaded transport trolley back

1. Provision for two tracks with track stop.
Slide on from the side with the upper hook in the T-slot on the track. Let it rest on the support.
2. Box with locking mechanism for Radio remote control and cable.
Lock with the eccentric lock on the box.
3. Two lifting eyelets
4. Bracket for max Ø800 mm saw blade and hooks for the blade guard (max Ø800)
Put the blade flange (which is fitted on the saw blade) on the bracket from above. Slide the blade guard over the saw blade from above and let it rest on the two hooks. Lock the blade guard in place with the blade guard locking mechanism (see 3.6)
5. Hook for machine cable, water hose and blade guard holder
Roll up cables and hoses in safe way and hang them on the hook. The blade guard holder can also be put here.
6. Bracket for two track feet
7. Bracket for Pentpak with two rubber straps.
The power pack should be positioned as in the picture and fastened with two rubber straps from the hooks on the middle part, through the holes to the front plastic hooks on the bracket.
8. Tool box for two track feet and extra equipment
The tool box must be lifted slightly upwards and out to open. Extra space for drilling machine.
9. Safety strap for track and tool box
Pull the long rubber strap from the hook on the side bracket behind the track, over the tracks, under the handle on the tool box, and fasten on the little hook on the foot.
10. Bracket for saw unit
The saw unit is fastened at the back by clamping it with its locking device.

3.2.2 Safety instructions for transport trolley

Risk of falling items causing serious personal injury if not used correct and with caution.

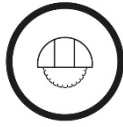

WARNING!

- If the transport trolley is to be lifted the blade guard **must** be correctly fitted and secured over the saw blade. Never lift the transport trolley with only the saw blade fitted! If the trolley tilts over during lifting, the saw blade can fall out of the trolley can cause fatal injury.
- The total weight of the trolley including load may not exceed 170 kg to be able to drive and lift it securely.
- The transport trolley may only be loaded with the machine and accessories as instructed in 3.2.1. Extra equipment may be stored in the lower tool box. Other use is not intended.
- Tracks longer than 2.3 m can rend the transport trolley unstable and make it tilt over, which can damage equipment and property. Never load more than 2 pcs of 2.3 m track. The track must be long enough to reach the upper hooks.
- The transport trolley should be placed on a stable, flat surface. If placed on a sloping surface, it may become unstable (slope $<5^\circ$). Also consider the stability if the trolley is loaded unevenly.
- Do not lift or move the transport trolley unless all loaded parts are positioned correctly in the specified location and securely fastened without risk of something falling off. Always use the locking functions and safety straps.
- Lifting with a crane may only take place by using the two lifting eyelets at the same time and the lifting force must then be as vertical as possible. When lifting at an angle, it must not exceed 45° (See picture below). The lifting equipment must have been tested and approved.
- Never stand below or near the load during lifting.
- The power pack should always be shut off and disconnected from the mains before moving the transport trolley.
- See also 2.3

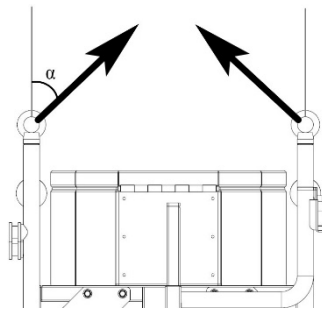

Instruction lifting with lifting eyelets. $0 \leq \alpha \leq 45^\circ$

3.3 Mounting of track feet and tracks

3.3.1 Positioning of track feet

1. Use the Pentruder templates to simplify the setup of the wall saw. It will help position the track feet to avoid re-aligning them when cutting a rectangular opening. The track foot can swivel, so it only needs to be set up once at each corner, for example when cutting a door opening.
2. Minimum two track feet are required to mount one track. The distance between the track feet may not exceed 2.0 meters (79"). If blades larger than 1200 mm / 48" are used, set the track feet closer than 2.0 meters / (79").
3. If tracks with only one gear rack are used, make sure all of them are positioned correctly to engage with the travel gear on the wall saw.

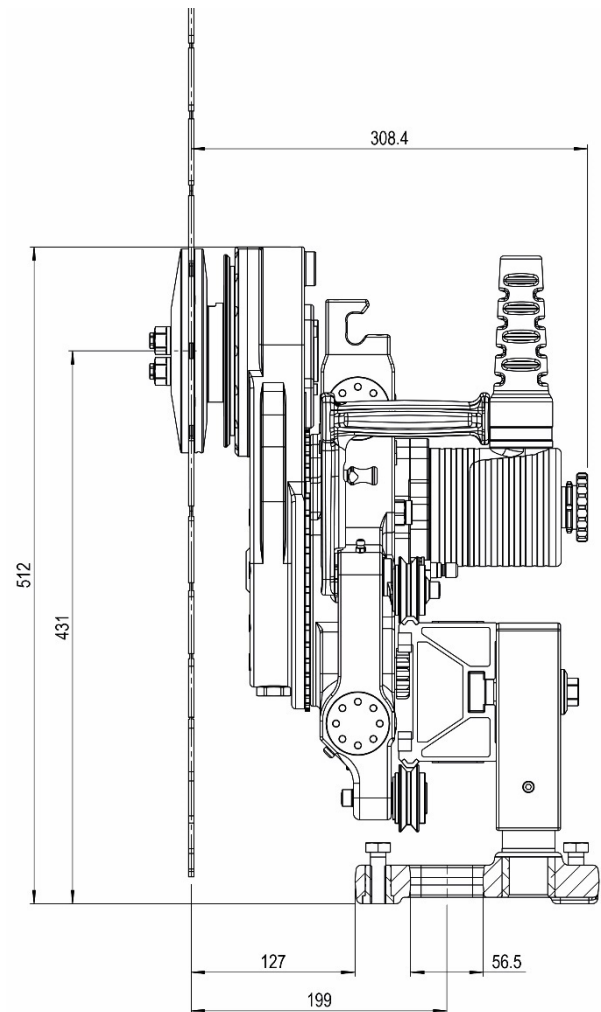
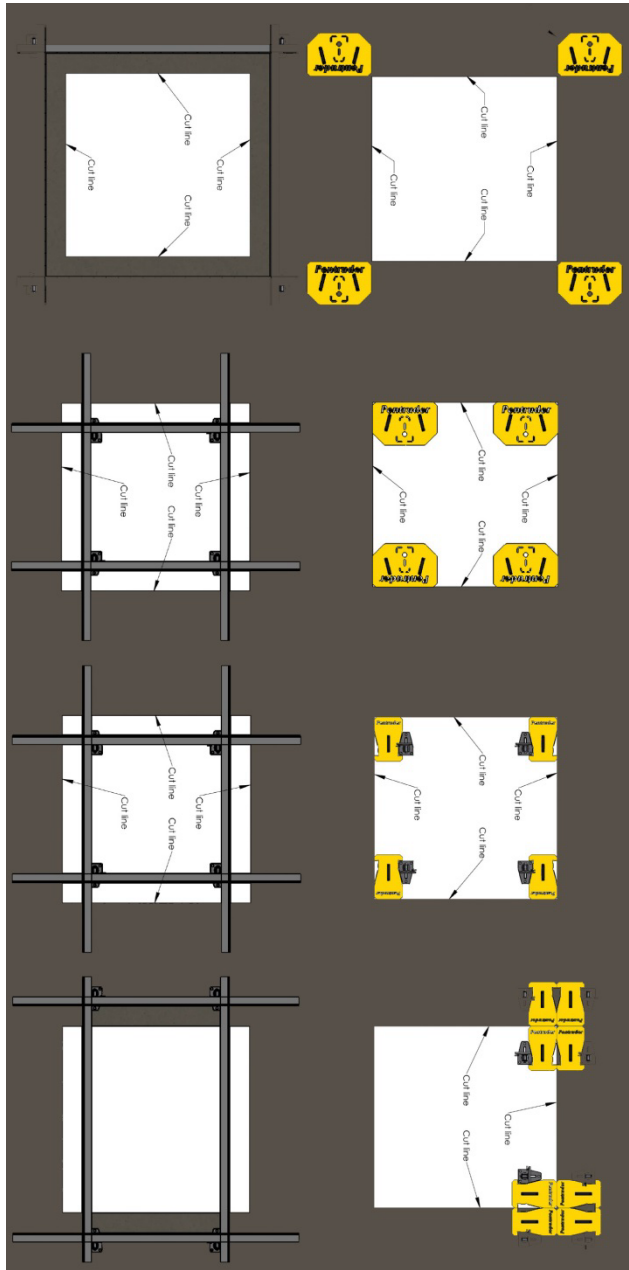

The distance from the edge of the feet to the cut line is 127 mm (5"). The distance from anchor bolt to the cut line is 217 +/- 25 mm (8.54 +/- 1").

Setup examples



Important!

The feet must be fixed with M12 (1/2") screws of 8.8 quality or higher of adequate length, depending on anchor depth, using a thick washer and anchors of type HKD M12 (1/2") or equivalent.



WARNING! MOUNT ACCORDING TO INSTRUCTIONS

Risk of serious or fatal cut from saw blade. Uncontrolled movements of the saw or an escaping or falling saw blade may result in injury or death. Risk of injury from falling parts.

Uncontrolled movements of the saw or an escaping or falling saw blade may result in injury or death. Risk of injury from falling parts.

- Track feet may only be mounted according to instructions given in this manual.
- Ensure that the surface where the track feet are fastened is stable, free of obstacles and adequately lit.
- The track feet and the tracks should be mounted in such a way that they cannot become detached when the machine is working, or at sudden changes in load on the anchor bolts.
- Track stops must always be securely mounted at each end of the track(s) to prevent the saw head from being run off the track unintentionally.
- If HKD type anchors or other high-quality expansion anchors cannot be fixed securely, the track feet must be securely fixed with through bolts and large washers to achieve the required level of safety.
- Do not use the machine if the track feet cannot be fastened properly.
- Make sure that the fork is not threaded all the way out before the track is mounted. Leave at least one turn from the fully out or in position of the fork.

3.3.2 Track system parts

- Track stop
- Knurled knob
- T-slot piece
- Fork
- Sleeve nut
- Levelling screws x 3

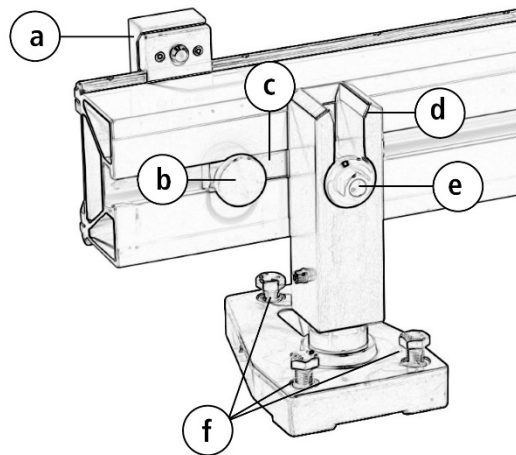

Note!

The **track feet** should preferably be mounted in the position shown in the picture above, with the base plate of the track foot under the track. If the track feet must be mounted differently due to the circumstances, this will affect the stability of the track and more track feet should be fitted to spread the load for increased stability.

3.3.3 Fastening track feet, and mounting the track on to the track feet

1. Drill anchor holes for each **track foot**. Follow the manufacturer's instructions for the anchors that are used.
2. Clean the holes and insert the anchors. Fix them according to the manufacturer's instructions.
3. Place both **track feet** over the anchor holes and tighten the bolts loosely.
4. The height of the **fork** can be adjusted totally 12 mm by turning the fork Clockwise or Counter Clockwise to compensate for irregularities on the wall. Adjust if necessary.
5. When the **fork** is completely turned in, turn the fork about 5 turns Counter Clockwise to make sure the saw arm doesn't touch the concrete.
6. Align and position the **first track foot** with the help of a template, set square, level or measuring tape.
7. Adjust the **levelling screws** if necessary and tighten the anchor bolt for the first track foot.
8. Slide in the **T-slot pieces** from both **track feet** into the **T-slot of the track**.
If you are using very old tracks with only one gear rack, make sure it is positioned correctly to engage with the travel gear on the wall saw, see 3.4 Mounting the saw head on the track.
9. To make sure the **knurled knobs** are not lost, tighten them securely.
10. Slide the **sleeve nut** into the **fork** of the first **track foot** in any chosen position longitudinally on the track.
11. Tighten the **sleeve nut** on the second **track foot** to 50 Nm. The hex is 19 mm (3/4").
12. Slide the **sleeve nut** into the fork of the second track foot in any chosen position longitudinally on the track. Do not tighten at this point.
13. Adjust the **levelling screws** on the second **track foot** so that the track is not warped due to unevenness of the concrete.
14. Fasten the **sleeve nut** on the second **track foot** to 50 Nm. Make sure there is no or a very small gap between the track foot fork and the track.
15. **Track stops** should always be fitted at the end of the track.

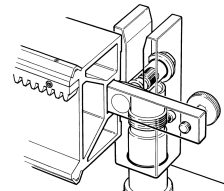
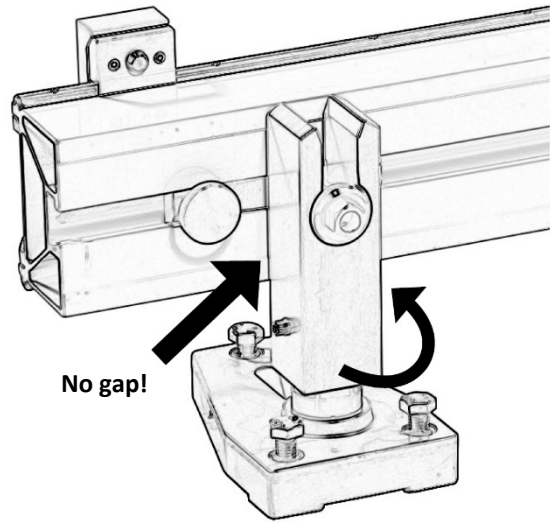

WARNING!

- Be careful to position the sleeve nut in the bottom of the fork on the track foot. This countersink at the bottom of the track foot is to prevent the track coming off the track foot in case the sleeve nut is not tightened properly.
- **If tracks with only one gear rack are used, make sure all of them are positioned correctly to engage with the travel gear on the wall saw.**
- Track stops must always be fitted at the end of the track.



Important!

The distance between the track feet should be no more than 2 meters / 79". When bigger blades than 1200 mm / 48" are used, we recommend setting the track feet closer than 2 meters / 79".



Note!

Be sure to check that the fork is aligned with the track and that there is no gap which can cause the track to be warped and the blade to cut un-straight.

3.3.4 Joining two or more track tracks together

If tracks are to be joined without a joint block the fork of the track foot should be positioned centrally under the joint. True up the tracks carefully using a spirit level or a straightedge.

When using joint blocks, a track foot must be placed within 60 cm (2 ft) of the joint Block.



WARNING!

- Joint Blocks are for connecting two tracks together and are not designed to alone handle the full load of the saw when cutting, therefore, one track foot must be mounted within 60 cm (2 ft) of all Joint Blocks).
- If tracks with only one gear rack are used, make sure all of them are positioned correctly to engage with the travel gear on the wall saw.

3.4 Mounting the saw head on the track

- Lifting handle x 2
- Locking pin x 2
- Upper track rollers
- Lower track rollers

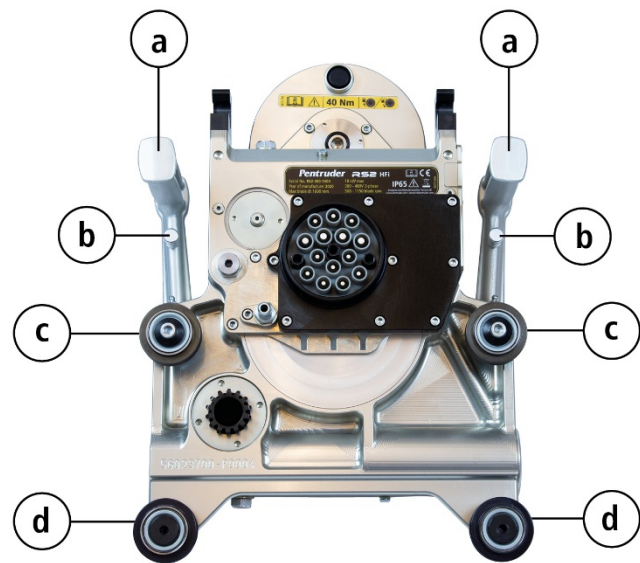

The saw head runs on the track on four track rollers. The upper track rollers are fitted on eccentric shafts, opened and locked by moving the handles sideways.

1. To open the **lifting handles**, lift up the **locking pins** using the index fingers, and fold the **handles outward from the saw** until they lock the most outward, open position.
2. Fold the saw head onto the track, the **bottom track rollers** engaged first, and second the **upper track rollers**.
3. Move **saw head** slightly along the **track** to engage the **travel gear** with the gear rack.
4. Lift up the **locking pins**, slightly move the **locking pins** and move the **lifting handles** toward the saw, until they are engaged in locked position.



WARNING!

Before the saw is operated, always make absolutely sure that the lifting handles are locked in position to prevent the saw from falling off the track.

Note that if a track with only one gear rack is used, it must be positioned in the right direction to engage with the travel gear on the wall saw. Failure to fulfil this requirement may lead to the saw head traveling along the track which potentially could cause severe bodily injury or death.

3.5 Mounting of saw blade

3.5.1 Function principle of quick disconnect coupling for the saw blade

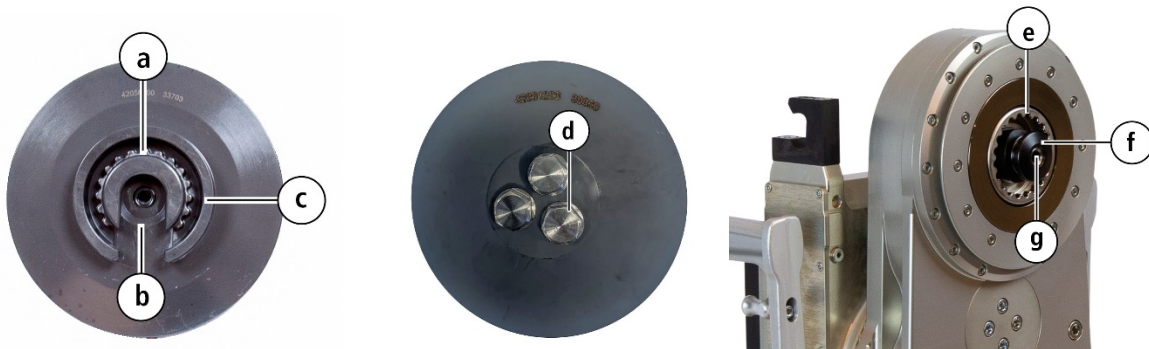

Inner blade flange

- a. Internal tothing (on inner blade flange)
- b. Radial t-slot
- c. Outer collar

Outer blade flange

- d. Bolts x 3

Spindle parts on wall saw head

- e. Internally toothed drive hub
- f. Pull stud
- g. Tapered guide cone

The saw blade is clamped between the inner and outer **blade flanges**. **Three bolts** clamp the blade between the flanges. For flush cutting, the blade is attached on a flush cutting flange by means of six (6) **countersunk screws**, and self-locking type **nuts**, on the back side of the flange.

The blade flange, regardless of type, is provided with a **radial T-slot** to the center of the flange. The flange, with blade fitted, is mounted on the **machine spindle** and its **pull stud** which fits in the **T-slot** in the flange. By turning a Locking Screw clockwise, the flange coupling can be locked and unlocked.

The flange is driven by the spindle by means of an **internally toothed drive hub** which grips into a corresponding external **tothing** in the flange. This hub is also provided with a **tapered guide cone** part which centers the flange on the spindle and at the same time interlocks the coupling.

3.5.2 Diamond saw blade

Only a diamond blade suited for the power of the machine and the material to be cut, concrete, stone material or masonry, may be used. Never attempt to use a higher spindle speed than the saw blade is intended for. Always follow the diamond blade manufacturer's recommendations.

For best cutting performance, check that the correct direction of rotation for the saw blade is used. Please note that if the direction of rotation of the blade is reversed, it usually takes a while before new diamonds are exposed and the blade starts to perform again.



WARNING!

Failure to respect these requirements may lead to serious or fatal injury to persons in the surroundings of the machine.

- Never attempt to use a higher spindle speed than the saw blade is intended for.
- Always follow the diamond blade manufacturer's recommendations.

3.5.3 How to fit a saw blade on a standard blade flange:

Centre bore and thickness

- The saw blade bore should be $\varnothing 60 \text{ mm} -0 +0.1 \text{ mm}$.
- The thickness of the saw blade core **must** be within 2.9 - 5.0 mm to ensure safe and proper clamping of the blade.

See picture below.

Checks and maintenance before use

1. Before use, carefully inspect the **saw blade** and the **saw blade bore**. The steel core **must** be completely free from cracks, dents, burrs and dirt and corrosion, or any kind of mechanical damage.
2. Make sure the **friction surfaces** of both flanges are undamaged and clean, free from grease and dirt. This is extremely important to allow the blade flange to be able to securely transmit the torque of the spindle without slippage. Slippage will cause irreparable damage to the flanges and the blade.
3. Inspect and grease the **threads** on the **three bolts**. Use a high-quality grease, preferably a Molybdenum Disulfide grease. No parts of the blade flange or bolt may ever start to corrode.

Clamping

4. Fit the blade on the inner flange and clamp it with the outer flange by tightening the three **bolts to 70 Nm**. A torque wrench must be used.
5. The blade and flange are now ready to be fitted on to the machine spindle by using the quick coupling.

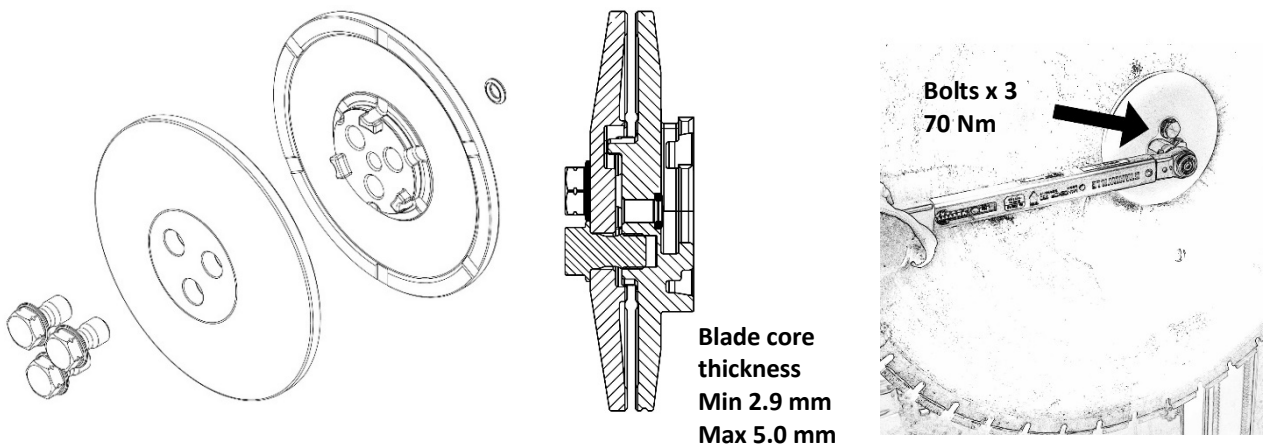

Failure to respect these requirements may lead to serious or fatal injury to persons in the surroundings of the machine.



WARNING!

- The three bolts are manufactured from a very high grade aerospace quality stainless steel. The threads on the bolts may never be allowed to be dry. They must always be greased with a high-quality grease, preferably a Molybdenum Disulfide grease. Tightening dry fasteners may cause loss of bolt tension which can result in several serious problems: Lack of clamping force on the blade, which in turn can result in serious injury, and even fatal injury to persons in the surroundings of the machine, as well as bolt fatigue due to low bolt preload.
- To avoid danger, the saw blade must always be fitted correctly, and a torque wrench must be used to tighten the bolts to the correct torque. The instructions given above must always be followed to avoid incorrect and dangerous mounting of the blade.

3.5.4 How to fit a saw blade on a flush cutting flange:

Bolt circle

The blade is fixed with 6 countersunk screws. The blade must have a bolt circle where the holes are spaced on an even and exact pitch to prevent unequal load distribution on the screws, blade and flange.

The following bolt circles and sizes are available.

- QEFRS60-130 Flush cutting flange, 60 mm arbor size, 6x M8 BC 130 mm on 130 mm Pitch Circle Diameter
- QEFRS60-110 Flush cutting flange, 60 mm arbor size, 6x M8 BC 110 mm on 110 mm Pitch Circle Diameter
- QEFRS60-108 Flush cutting flange, 60 mm arbor size, 6x M10 BC 108 mm on 108 mm Pitch Circle Diameter

Screw and nut quality

The blade must be clamped with countersunk screws of highest quality, like Unbrako or equivalent, and be of quality 10.9. To avoid corrosion, use only zinc plated (or similar coatings) bolts and nuts. The nuts must be of type "Nyloc".

Maintenance before use

1. Inspect the **saw blade** and the **saw blade bore**. They must be free from cracks, dents, burrs and dirt and corrosion.
2. Make sure the **clamping/friction surface** of the flange is clean, and free from grease and dirt. This is important to be able to securely transmit the torque of the spindle. A loose blade poses a great safety risk.
3. Inspect and grease the **threads** on screws and nuts. No parts of the blade flange or screw may ever start to corrode.

Clamping

Fit the blade on the flush blade flange and clamp it with the six 10.9 quality screws. The fasteners must be torqued with a torque wrench to 35 Nm for M8 screws and to 50 Nm for M10 and 3/8" screws. The threads must be lubricated with grease.

**35 Nm: M8
Countersunk screws,
6 x M8, Unbrako
10.9 + Nyloc nuts**

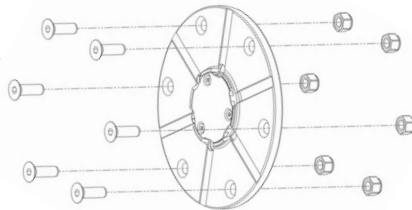

**50 Nm: M10 (3/8")
Countersunk
screws,
6 x M10, Unbrako
10.9 + Nyloc nuts**

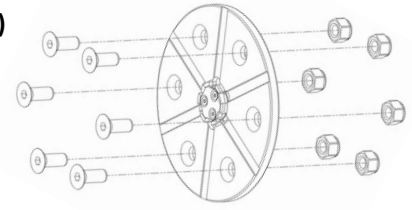

Blade guard

When flush cutting, the blade guard cannot protect for the danger of ejection cutting debris and potentially a loose segment. Therefore protection should be built up around the saw blade to protect the operator and all other persons in the surroundings of the wall saw.

The blade and flange are now ready to be fitted on to the machine spindle with the quick coupling.



WARNING!

Failure to respect these requirements may cause failure which can result in serious or fatal injuries to persons in the surroundings of the machine.

- The saw blade must always be fitted correctly to avoid danger.
- It is important to be aware that when a flush cutting blade is used, the blade is clamped merely by the six countersunk screws, nothing else.
- When flush cutting the operator should be aware that the level of safety never can be comparable to normal cutting with a full blade guard. Flush cutting is a potentially dangerous method and should be treated likewise.
- *When flush cutting, the blade guard does not protect properly for the danger of ejection of cutting debris and potentially a loose segment. **A protection should be built up around the saw blade to protect the operator and all other persons in the surroundings of the machine. This is also valid for any situation where a side piece of the full covering blade guard must be removed.***
- Look out for cracks around the counter sunk holes in the blade. Some blades are prone to crack and if that happens, they may not be used as it can lead to a very dangerous situation and fatal accidents. A faulty saw blade with cracks, dents, burrs or loose segments must never be used.

3.5.5 Mounting the saw blade with flange on the machine spindle

When the blade is securely fitted on the blade flange, it can be fitted on to the machine spindle.

1. On the opposite side of the flange T-slot there is a groove, and this groove should be positioned upwards when the blade flange is mounted on to the saw head spindle / pull stud. See picture below.
2. To lock the blade flange coupling,
 - a. rotate the **saw blade** slowly while pressing the **detent button**, until the **spindle** is blocked.
 - b. turn the **clamping screw** clockwise to lock the blade flange coupling.
Use a torque wrench to tighten the **clamp screw** to **70 Nm**. Do not overtighten!

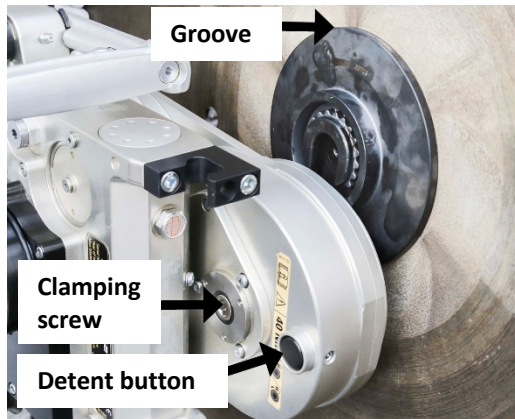

3. To unlock the **flange coupling**
 - a. Rotate **saw blade** slowly while pressing the **detent button**, until the spindle is blocked.
 - b. Turn the **clamping screw** CCW to open the **coupling**.



WARNING!



- Always keep all part of the coupling clean and lubricated! The safe operation of the coupling depends on cleanliness of all coupling parts on the machine, and the blade flange!
- Do not use the machine if any part of the quick disconnect coupling is corroded or damaged.
- Failure to follow the assembly instructions above may result in coupling overload and a failure can result in serious injury and even to fatal injuries to the operator or persons in the surroundings of the machine.
- Before any kind of service, maintenance or mounting on the machine is commenced, the machine must always be disconnected from the electric power supply.

3.6 Mounting the blade guard

3.6.1 Mounting of GH-RS2 blade guard holder and GPRS blade guards

Mounting the blade guard holder

1. Grip and pull the round bar on the blade guard holder while folding it into position.

Mounting the guard

2. Slide the blade guard on to the groove on the saw arm.
3. Steer the blade guard guide blocks on to the blade guard holder, making sure the pins on the guard rail slide into the T-shaped grooves on the guard, as shown in the picture.
4. Turn the two locking mechanism levers on both sides to lock the guard in place.
5. The side parts (yellow) can be removed if the blade needs to cut into an adjacent wall or floor, for example. To open the lock handle and clamp which clamps a side piece to the center part of the guard, release the locking pin on the lock lever and fold the lever upwards. The clamp will then open, and the side piece can be pulled off the guard.

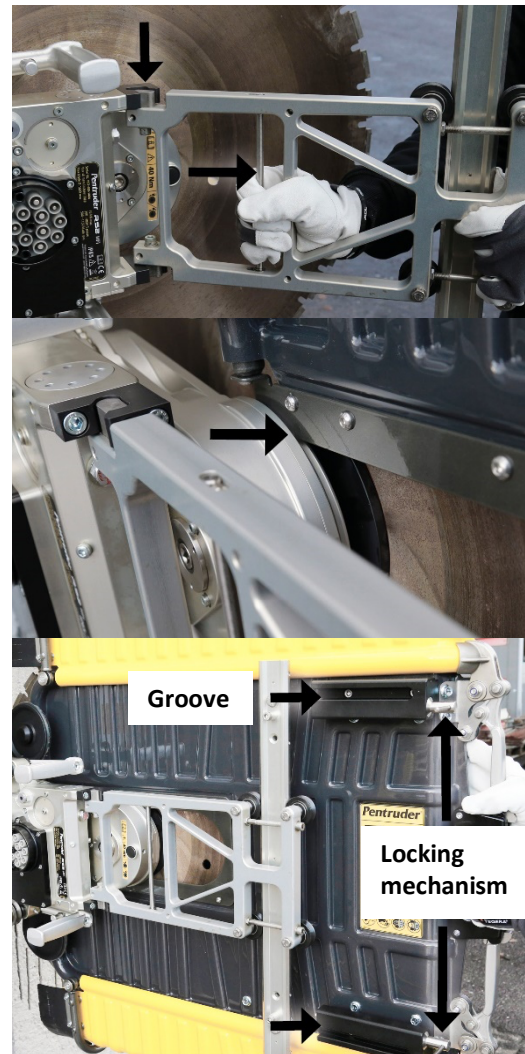

WARNING!

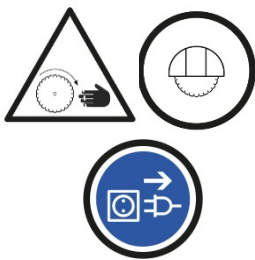

- No mounting may be done on the machine before the Pentpak 3i is disconnected from the electric power supply. This rule must always be followed to eliminate the risk that the blade motor is started by accident or the arm or chassis moves when the operator is working on the saw head.
- The blade guard **must always be mounted** when the blade is rotating under power.
- Never remove the side pieces when the saw blade is rotating under power, and never, under any circumstance if the intent is not to cut into an adjacent structure.
- **The blade guard must be attached to the saw as a way protect the operator and the surrounding area from:**
 - Water and loose material which is cut away by the blade and thrown out of the cut.
 - Accidental injury in a situation when the operator or **another person** accidentally falls **towards** the machine.
- **The blade guard is not able to protect people in the vicinity of the machine by failing, cracked or faulty blade or from injury caused by loose segments which are thrown out of the cut or by a blade which is not properly fitted. Faulty or cracked saw blade may never be used, under any circumstances.**
- Failure to follow these instructions can result in serious **injury or** fatal injuries to persons in the **surroundings** of the machine.

3.7 Connecting the RS2i to Pentpak 3i

3.7.1 Machine cable

Both high and low voltage electric power from the Pentpak 3i power pack to the RS2i is supplied by one 9 m machine cable. The machine cable also contains wires for communication between the power pack and the machine. The machine cable may not be longer than 9 m.



WARNING!



No mounting may be done on the machine before the machine is disconnected from the electric power supply. This rule must always be followed to eliminate the risk that the blade motor is started by accident or the arm or chassis moves when the operator is working on the saw head.



Important!

Check that all cables and connectors are undamaged and in faultless condition. Make sure all connectors are clean and dry. Do not lubricate the pins and sockets since they then will attract more dirt than when clean and dry.

3.7.2 Cooling water

Cooling water is supplied from the Pentpak 3i power pack to the machine using the water hose supplied with the machine. Connect as shown in the pictures below.

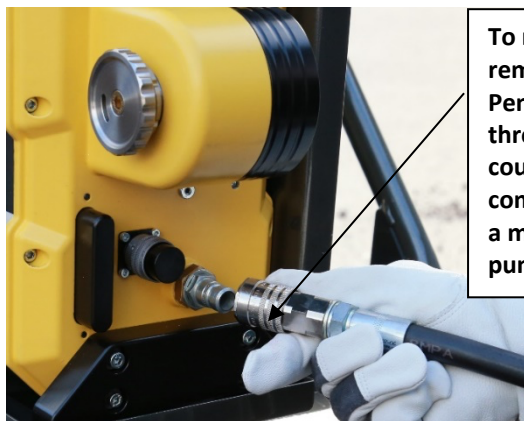

To remove water remaining in the Pentpak, blow through this coupling with compressed air or a manual air pump.

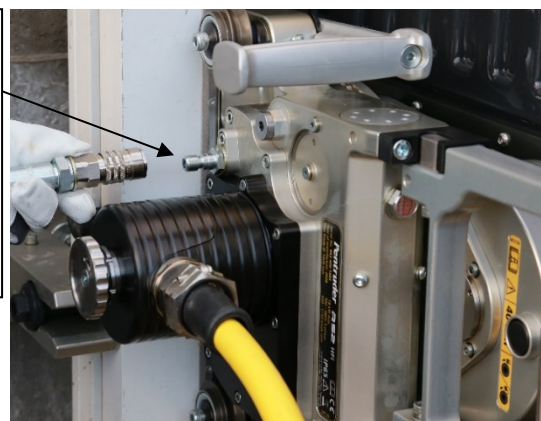

Emptying the saw head, water hose and power pack of water in sub-zero temperatures

In sub-zero temperatures the remaining water inside the power pack cooling circuit must be blown out with compressed air. Disconnect all water connections and blow air through the water connections.



Important!

Leaving remaining water in the Pentpak in sub-zero temperatures will potentially destroy electronic components inside the box.

3.8 Pentpak 3i, Power pack – connections and functions, input side

- Emergency stop
- 3-phase input power
- Water connection
- Cover, see 3.8.1
- Green button
- Voltage indicator

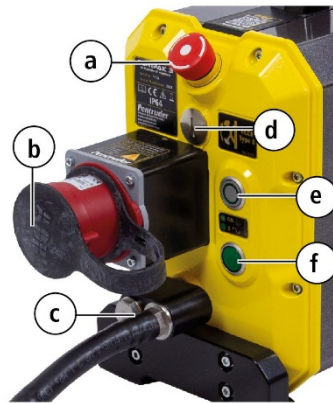

3.8.1 Residual Current Circuit Breaker, RCCB (Ground fault circuit breaker)



- Built in RCCB type B which protects from electric shock in case of damaged or broken cables, connectors, etc. If the RCCB trips, input power will be shut off.
- No built in RCCB. Pentpak 3i, HFi, 380-480V
- No built in RCCB. Pentpak 3i, HFi, 480V



Important!

In countries where the machine must be connected to a residual current breaker (RCCB), the RCCB must be of Type B. It is the responsibility of the user of the machine to make sure the machine is connected to the correct electrical supply.

3.8.2 Electrical supply from mains/grid

Connect the Pentpak 3i power pack to a 5 pin 380 - 480 V, 50-60 Hz, 32A socket 3-phase supply with Protective Earth (PE), minimum 16 Amp fuses. A neutral-line is NOT required. To be able to extract maximum power from the RS2i wall saw, 32 Amp fuses are required.

The power pack is equipped with a 32 Amp receptacle. To use other sizes than 32 Amp plugs an adapter must be used.



Important!

Check that all cables and connectors are undamaged and in faultless condition. Make sure all connectors are clean and dry. Do not lubricate the pins and sockets since they then will attract more dirt than when clean and dry.

3.8.3 Electrical power supply from mobile generator

It is important that when a mobile generator set is used, it complies with the recommendations. See technical data for details about required size of mobile generator. Do not power any other machinery from the mobile generator set at the same time as the RS2i.



Important!

If the mobile generator's electrical capacity is too low, there is a significant risk of destroying power electronics in the Pentpak 3i.

3.8.4 Requirements for the electrical supply according to EMC directive

This machine is OK to install on any socket connected to a supply with a large enough short circuit power. It complies with IEC 61000-3-12 provided that short-circuit power SSC at the interface point between the user's supply and the public supply network is greater than or equal to 350 MVA.

It is the responsibility of the installer or operator of the machine to ensure, by consultation with the supply network operator if necessary, that this device is connected only to an interface point with an SSC rating greater than or equal to 350 MVA.

3.8.5 Extension cable

An extension cable may be used. The size must be adequate for the length:

- Extension cable 1-50 meters: min 6 mm² CU (10AWG)
- Extension cable 50-100 meters: min 10 mm² CU (8 AWG)

3.8.6 Water supply

The power pack is water cooled and needs a minimum of 6 liters of cool water per minute at full power output. The water pressure should be at least 1 bar and maximum 6 bar.

The water supply should be connected to the input side of the power pack.

3.8.7 Water filter

There is an inline water filter supplied with the machine that connects to the input water connector on the Pentpak. The water filter should be checked regularly. See chapter 6 Maintenance

If the water filter is clogged, the motor and saw blade does not get enough cooling water, and the power will be lowered to the blade. The power is shown in % on the Radio remote display as a percentage of maximum power.

3.8.8 Positioning

The power pack should be positioned away from where the sawing takes place **and should be kept dry at all times**. It should be placed on a flat surface. See also 3.2 Transport trolley.

Protect the Pentpak 3i from direct sunlight when the temperature is above approximately 25° C (80° F). If the ambient temperature inside the Pentpak 3i rises above 60° C (140° F) the Pentpak 3i will shut off to protect the electronics.



3.9 Radio remote control

3.9.1 Radio remote control overview

- a. **LED1**; Green, Connection status. See also display
- b. **LED2**; Red, Emergency stop button activated, low battery
- c. **DISPLAY**; LCD-Display
- d. **Display buttons**



Background light on display



Menu push button



“-“ Browse in menu



“+“ Browse in menu



Enter

e. **Joystick:**

- Right, with detent function
 - Left, with detent function
 - Up/Forward, automatic spring return
 - Down/Rearwards, automatic spring return
 - Center
- The Joystick can simultaneously be activated sideways and up or down.

- f. **RPM**; Main motor rpm knob
- g. **PWR**; Feed and power regulation knob
- h. **WS**; Switch for water
- i. **MS**; Switch for main motor
- j. **EMERGENCY STOP**; Stop button
- k. **ON/OFF** push button
- l. **Connector** for remote control cable (radio disabled)
- m. **Key hole**
- n. Battery charger
- o. Battery (2 pcs)
- p. Receiver
- q. Remote control cable (radio disabled)

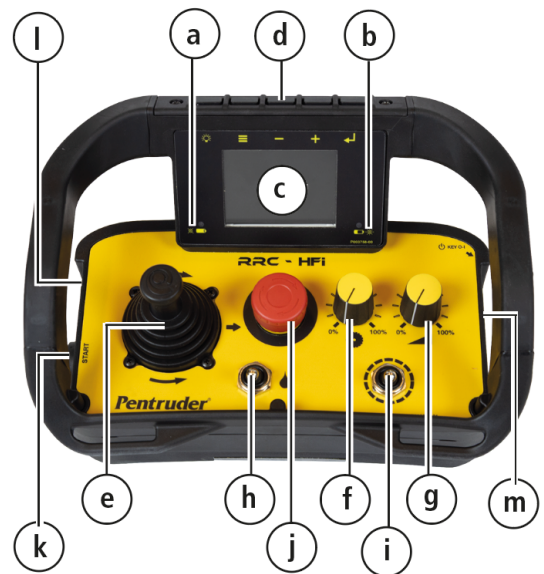

For more information, see 4. Cutting and the displays.

3.9.2 Positioning and connection of the receiver

The receiver can be placed with magnets either on the side of the PP3i when the trolley is not being used or placed on the holder underneath the Remote box on the trolley.

The receiver connects to the RRCi connector (r).

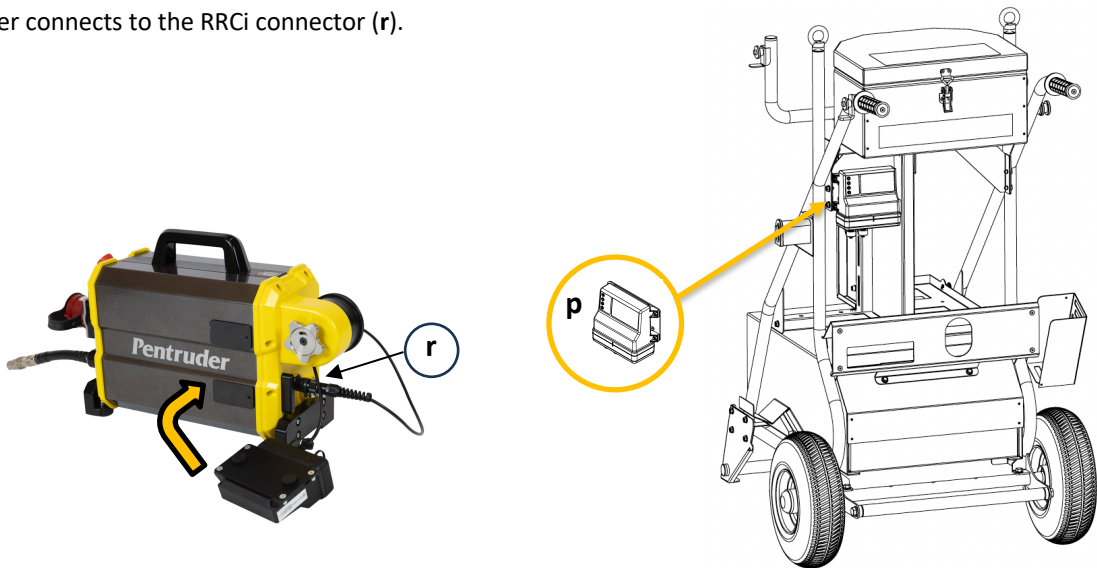

3.9.3 Batteries for radio remote control (RRCi)

The RRCi uses rechargeable Lithium batteries.

The RRCi batteries will last for approximately 10-15 hours of continuous operation. LED2 will indicate low battery. There will also be a warning on the display when the batteries are low.

To recharge the batteries, use the battery charger powered from either 12/24VDC or 110-240VAC. Make sure to use the correct adapter. For more details, see Autec Instruction manual for the use and maintenance of battery and battery charger at Pentrunder.com.

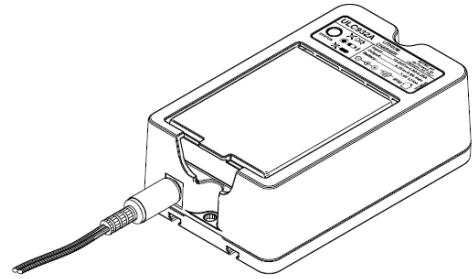

3.9.4 Using remote control (RRCi) and Pentpak 3i (PP3i) with radio

Pairing

Your transmitter is paired with the receiver connected to the Pentpak 3i. Should you need to use another Radio remote control for your Pentpak 3i, please note that the receiver is paired with the transmitter, which means you need to replace both as a pair. It is possible to re-pair. Contact your Pentrunder authorized distributor.



3.9.5 Using remote control (RRCi) and Pentpak 3i (PP3i) with cable

When using the Remote control cable, connected between the transmitter and receiver, the RRCi will function like a cable remote control. Radio is disabled.

Note that you can use the remote control with cable even without battery.



Important!

Turn off the key on the remote control when the machine is not in use, to make sure unauthorized persons cannot unintentionally start the machine.

3.10 Peripheral cutting speed and spindle speeds

It is important that the peripheral cutting speed is suitable for the blade size and overall circumstances.

3.10.1 Automatic identification

The Pentpak 3i is equipped with automatic identification of blade size, "auto". If auto is chosen the machine will automatically detect blade size during startup and adjust the maximum setting on the RPM knob. The rpm can always be reduced with the RPM-knob.

3.10.2 Choose correct cutting speed manually

- The peripheral speed of the saw blade can be adjusted with the RPM main motor RPM knob to suit the blade size used. A suitable peripheral cutting speed is normally between 35 and 55 meters per second. See chart below. Maximum peripheral cutting speed may vary from market to market.
- The peripheral cutting speed must be adjusted to the composition of the concrete, and the type, quality and condition of the saw blade.
- A rule of thumb is that harder concrete and/or high content of steel is more easily cut with lower speeds than normally used peripheral speeds, and vice versa.



WARNING!

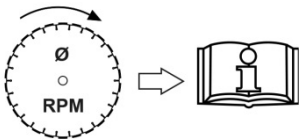

- Obtain information from your saw blade supplier regarding the maximum allowed rotational speed for each size of blade. As a rule of thumb, never **exceed 56 meters / second**.
- **A too high speed may cause loads on the saw blade resulting in saw blade failure or segments coming loose and be thrown out of the cut at high velocity.**
- For very hard aggregate the peripheral cutting speed should be kept low, 30 meters /second is a good starting point.
- **If a faulty setting of the blade speed potentiometer is used the blade can rotate at a too high peripheral speed, which can cause the blade to fail which can cause severe or fatal injury.**
- Especially when using big diameter blades the RPM, main motor knob must NOT be set at a too high value when cutting is started. See the chart below.

3.10.3 Spindle speed in rpm and m/second with Pentruder RS2i

Peripheral cutting speed and spindle speed in meters / second for different blade diameters with different setting on the RPM main motor rpm knob.

RPM setting, main motor knob	∅ 600	∅ 800	∅ 1000	∅ 1200	∅ 1600
0-10% = 560 rpm	18 m/s	23 m/s	29 m/s	35 m/s	47 m/s
20% = 650 rpm	20 m/s	27 m/s	34 m/s	41 m/s	54 m/s
30% = 690 rpm	22 m/s	29 m/s	36 m/s	43 m/s	58 m/s ⚠ not allowed
40% = 780 rpm	24 m/s	33 m/s	41 m/s	49 m/s	65 m/s ⚠ not allowed
50% = 820 rpm	26 m/s	34 m/s	43 m/s	52 m/s	69 m/s ⚠ not allowed
60% = 910 rpm	29 m/s	38 m/s	48 m/s	57 m/s ⚠ not allowed	76 m/s ⚠ not allowed
70% = 950 rpm	30 m/s	40 m/s	50 m/s	60 m/s ⚠ not allowed	80 m/s ⚠ not allowed
80% = 1040 rpm	33 m/s	44 m/s	54 m/s	65 m/s ⚠ not allowed	87 m/s ⚠ not allowed
90-100% = 1125 rpm	35 m/s	47 m/s	59 m/s ⚠ not allowed	71 m/s ⚠ not allowed	94 m/s ⚠ not allowed

The values are rounded. Maximum peripheral cutting speed may vary from market to market.

4 Cutting

4.1 Ready to cut?

When all the instructions in **Chapter 2** and **Chapter 3** have been followed, you are ready for the next step, "Connections and start up sequence".

The machine should be clean, properly lubricated and all functions checked before cutting is commenced. See the instructions in **Maintenance**



WARNING!

- Before starting to cut, it is essential that all personnel working with or in close proximity of the machine have read and understood the contents of this operator's manual and that the instructions are followed.
- If the safety precautions are not respected, this can result in serious injury and even to fatal injuries to persons in proximity of the machine.

In the following instruction:

- L1, L2, etc. refers to LED lights on the RRCi Radio remote control
- P1, P2, etc. refers to the Green button and Voltage indication on the Pentpak 3i
- D1, D2, etc. refers to the picture of each display.

A normal start up sequence is described. If anything does not comply, please see trouble shooting.

4.1.1 Connections, and startup sequence

1. Make sure that the Stop button on the **RRCi** and the Emergency stop button on the **Pentpak 3i** are released.
2. Connect the **RS2i saw head** to the **Pentpak 3i** using the **Machine cable** (3.7.1)
3. Connect the **Water hose** between the **RS2i saw head** and **Pentpak 3i** (3.7.2)
4. Connect **Pentpak 3i** to water supply (3.8.6)
5. Connect **Pentpak 3i** to the power source
6. Turn the start key on the RRCi to ON-position. (L1)(D1)
7. Press the Start button on the RRCi (see display) (D2). The PP3i green button will start blinking.
8. Press the PP3i green button to activate the emergency stop system. (D3)

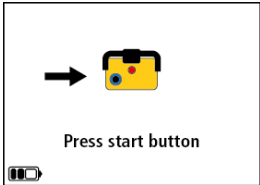
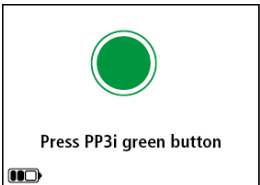
L1	LED1 (green) blinks, RRCi is ON	
P2	Voltage indicator on Pentpak 3i: ON	
D1	Shows Pentruder logotype	
D2	Press Start button to activate RRCi.	
D3	Press PP3i green button.	

9. Press Enter to confirm that a blade guard is fitted on the saw head. (D4)
10. Press Enter to choose auto detect. OR scroll down using the +/- to choose blade size manually.
The maximum available rpm at 100% on the RPM-knob is set to not be higher than 55 m/second. (D5)
11. Press Enter. (D6)

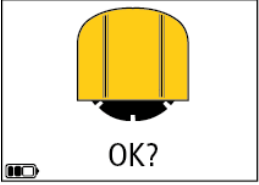
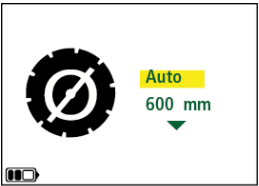
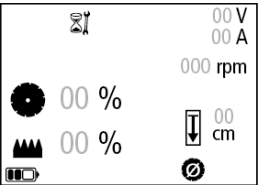
L4	LED1 (green) blinks	
P2	Green button on Pentpak 3i: ON	
D4	Blade guard confirmation Press Enter to confirm	
D5	Choose blade size	
D6	Cutting display	

**WARNING!**

Choosing the wrong blade size can lead to too high peripheral speed for the blade. Always double check the rpm when starting to cut. See Adjust the rpm below. Make sure the peripheral speed is not too high.

Start the main motor, alter rotational direction, and adjust the rpm, RPM – Main motor rpm knob

1. Turn the RPM knob and the PWR knob to zero and put the Joystick in neutral position.
2. Push the WS switch for water forward and hold, then within 5 seconds, push the MS - Switch for main motor forward, and then let go of both switches to start the blade. (D7)
3. The blade will start rotating slowly CCW (Counter Clockwise) seen from the connector side of the saw head.
4. Now, the blade rotational direction can be altered by pushing the WS switch once. If the WS switch is pushed once more the rotational direction will change again.
5. Adjust the rpm by turning the Blade speed control knob (RPM). (D8)
See 4.7 Peripheral cutting speed and spindle speeds
6. When the rotational speed is increased the blade rotation direction is set.
To change direction, push the Stop-button and start at 4.1.1, pos. 6.

The cooling water will be automatically switched on when the main motor is started.

D7

 Alter blade rotational direction
Counterclockwise

 Clockwise

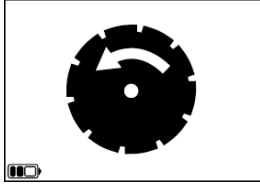

D8 Cutting display

 Water valve in PP3i open

V Voltage (mains/generator)

A Power in (Ampere)

RPM Spindle rpm during cutting

m/s Peripheral speed in m/second,
only shown if blade size was chosen

 Power (blade)
Percentage of max power
Rotational direction is shown in the symbol.

 Power (speed on track, feed/travel),
Percentage of max power

! The feed motors will not reach 100% of max power unless there is something mechanically wrong, eg. a stone blocking the movement on the track or the saw hits the track stop.

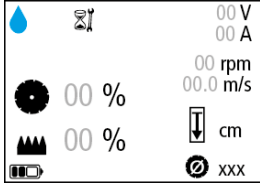



WARNING!

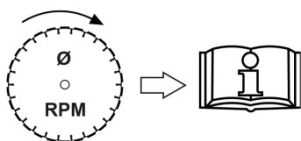

- The peripheral cutting speed may not exceed approximately 56 metres / second as this can cause the blade to fail. In the worst case, segments can come loose and be thrown with high velocity.
- For very hard aggregate the peripheral cutting speed should not exceed 30 meters /second.
- If the wrong setting is used the blade can rotate with a too high peripheral speed, which can cause the blade to fail and lead to fatal injury.
- When using big blades, the potentiometer for blade speed control may not be set at a too high % when starting to cut.

Feed and power regulation, PWR – Feed and power regulation knob

7. Set the PWR knob to a suitable setting for the situation.
As long as the blade is spinning in the air, the PWR knob is used only to control movement on the track and of the arm. From the moment the blade touches the concrete, and a pre-set amperage draw is exceeded, the PWR knob changes its function and is now used to control the power (amperage) used to drive the blade. (D8)



Note!

- The PWR-knob can usually be set at 100% during cutting.
- To be able to run the machine on a smaller fuse (e.g., 16 A), the PWR knob can be lowered to a setting where the fuse will not cut out. The display shows the power in ampere (A). Adjust the PWR-knob accordingly.

Plunge and travel (Joystick)

8. Move the Joystick up or down to rotate the radial saw arm. (D8)
9. Move the joystick left or right to move the saw head along the track. (D8)
10. The saw arm will always stop when it is “straight up” to facilitate mounting. Just flick again with the joystick to continue the movement on the saw arm.



Note!

A pre-cut not deeper than approximately 5 cm / 2 inches is always recommended to avoid that the saw blade cuts un-straight.

4.2 Special cutting features



Cutting depth indicator

When the blade size is chosen correctly, the blade is started and rotates at the chosen speed, the cutting depth indicator can be set. (D9)

1. Feed the blade towards the concrete surface and let go of the joystick just as the blade touches the concrete surface.
2. Flick the Water switch once to set the zero point for the depth indicator.
3. This can be repeated at any time as long as the blade is rotating to set a new zero point at a new depth.
4. Cutting depth will be indicated with a positive number next to the cutting depth symbol.
5. If you move the arm above the zero point, there will be a negative (-) number indicated next to the cutting depth symbol.

Changing to a bigger blade







6. The set zero point will be stored only until the machine is disconnected from the power supply.

<p>D9</p> 	<p>Cutting display – Cutting depth indicator</p> 
--	---

Plunge cut feature

The plunge cut feature makes it possible to feed the saw blade into the concrete at a perpendicular angle.

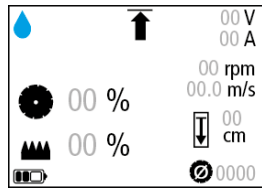
1. To activate the feature, move the joystick to the lower-left or lower-right position depending on which side of the machine you would like the cut. The blade will be plunged into the concrete at a perpendicular angle. (D10)
2. When maximum depth is reached, the feed will stop. (D11)
3. If the saw arm is positioned to the left of the center line and you pull the joystick to the bottom right, the red arrow symbol will be shown, to indicate that this is not allowed, and vice versa. (D12)

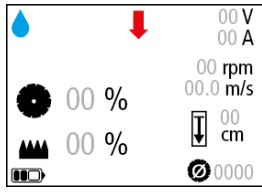
D10 Cutting display – Plunge cut feature	
<p>D10 Plunge cut feature activated. Blade is plunged into the concrete at a perpendicular angle.</p> 	
<p> When the plunge cut feature is active, and the joystick is moved to the neutral travel position (LH or RH) this symbol is shown.</p>	
<p>D11 Symbol for maximum cutting depth reached.</p>  	
<p>D12 Symbol for incorrect joystick movement.</p>  	

4.3 When cutting is finished

Stop the blade

To stop the blade, push the switch for the main motor (MS) upwards once.

Switch for water

Move the switch forward to start and stop the water flow through the machine. The water flow will be switched on automatically when the blade is started. The water will be left running when the blade motor is stopped, and the water must be switched off by pushing the WS Water ON/OFF switch once again.



Important!

- To protect the motors from overheating, they will be switched off automatically if the temperature becomes too high. The coolant water should then be left running through the power pack and machine to avoid terminal overheating.

4.4 Storage of the machine

- Disconnect the cables from the power pack before transporting the machine.
- The saw blade and blade guard should be taken off the saw head before transport.
- Make sure no unauthorized persons can get access to the machine when in transport and storage.
- If there is a risk of freezing, the machine must be drained from water. Pay extra attention to the power pack. See 3.7.2 Cooling Water.
- Store the machine in a dry place, preferably above freezing temperature.
- Follow the saw blade manufacturer's instructions for handling and storage of the saw blade.
- See also 3.2 Transport



Important!

- Do **NOT** leave the power pack outside in the rain. The unit is sealed but not watertight over time. To prevent possible damage to electronic components we recommend that it is kept dry to prevent excessive condensation forming.
-

5 Trouble shooting and menu functions

5.1 Saw blade issues

5.1.1 Jammed saw blade

The power pack has an automatic function for resetting the frequency inverter if the blade is jammed. Move the blade out of the cut, or at least to a position where it can be started without too much resistance, and press the MS main motor switch forward once, then it takes approx. 15 seconds for it to reset. Certain reset procedures are activated depending on how sudden the stop was.

If the blade is jammed very, very abrupt, the reset procedure might not be enough. In this case you need to unplug the unit from the power supply, wait for minimum 30 seconds and plug it in again.

**Note!**

If either of the Emergency stop button on the Pentpak or the Stop button on the radio remote control is pressed or the unit has been unplugged from the power supply, both the blade speed and the feed and travel potentiometers must be returned to zero before the machine is operational again.

5.1.2 The saw blade does not cut straight

Check if anything of the following applies.

- a. The track is not correctly mounted on the track feet. See 3.3 Mounting of track feet and tracks.
- b. The conical rollers that run on the track are not correctly adjusted. See Every day / week maintenance for instruction.
- c. There is too much play in the spindle bearings. The spindle bearings always have a little play, but too much play means the saw head has to be sent to your Pentrunder authorised service company to have the bearing replaced.
- d. The saw blade is damaged and/or badly balanced. Check that it is straight with a big set square. It is important that the blade is held upright in a vertical position when checking that it is straight.

5.2 The Pentpak, RRCi or RS2i do not work properly

5.2.1 Issues, possible causes and solutions

1. Check the display on the remote control for information. See indications on the RRCi display in chapter **Fel! Hittar inte referenskälla.** and list of error codes in chapter 5.2.2 and follow the instructions.
2. Check the Green button and Voltage indicator on the Pentpak 3i, and the LED's on the RRCi display. See chart below:

Issue	Possible cause and solution
The display shuts off after initial startup	Make sure the Emergency stop button on the radio remote control is released.
Voltage indicator on PP3i not illuminated	No power to Pentpak. Make sure Pentpak is connected to mains supply. See Voltage indicator on Pentpak.
	No power to Pentpak 3i, RCCB tripped (if applicable). Make sure Pentpak is connected to mains supply. Open the RCCB cover and reset the switch.*
Green button on PP3i goes off	Out of range. Reposition the RRCi in relation to the receiver
	Emergency Stop button pressed on PP3i or RRCi
	Radio issues (disturbance). Use the remote control cable
LED2, Red, blinking	Low battery. Replace with a charged battery or connect the remote control cable.

*Not applicable in markets outside of Europe. Contact your Pentruder authorized service workshop for information.



Important!

- The motor will be switched off automatically when the motor winding temperature is over 120°C (248°F). The coolant water should then be left running through the power pack and saw head to avoid terminal overheating.
 - If the water is turned off after the motor has been switched off automatically, and when the warning light is on, terminal damage to the motor windings may occur.
-

5.2.2 Error codes on RRCi display

Error codes (page 1)	Issue	Unplug from Mains supply	Remote control	Auto reset	Update Firmware	Replace/ upgrade Machine
E1001-E1008	Pentpak ambient or cooling water temperature too high			x		
E1010-E1012	Emergency stop or Green button on Pentpak faulty			x		
E1601	Main motor shut off due to slip clutch slipping		MS			
E1604 / E1607	Main motor overheated / temp-sensor fault			x		
E1605 / E1608	Travel motor overheated / tempsensor fault			x		
E1606 / E1609	Arm feed motor overheated / tempsensor fault			x		
E1620	RS2 sawhead connected, not compatible with PP3i					x
E1621	Unknown machine connected to PP3i				x	
E1698	Unsupported software version				x	
E1699	No communication with Machine			x		
E1897	CAN TX errors, communication with RRCi			x		
E1898	Unsupported software version				x	
E1899	No communication with Receiver (RRCi)			x		
E2101	Hardware error, Pentpak, drive board, arm feed			x		
E2201	Hardware error, Pentpak, drive board, travel			x		
E2401	Hardware error, Pentpak, drive board, main motor			x		
E2102, E2202, E2402	Machine cable failure, open circuit			x		
E2103, E2203, E2403	Machine cable failure, leakage or faulty connection			x		
E2109	Overcurrent detected, arm feed Joystick		Joystick			
E2209	Overcurrent detected, travel Joystick		Joystick			
E2409	Overcurrent detected, main motor		MS			
E2111, E2211, E2411	Internal fault, Pentpak, drive board			x		
E2113, E2213, E2413	Over voltage, mains supply to Pentpak			x		
E2114, E2214, E2414	Under voltage, mains supply to Pentpak			x		
E2115, E2215, E2415	Internal fault, Pentpak drive board			x		
E2198, E2298, E2498	Unsupported software version				x	
E2199, E2299, E2499	No communication with Drive (Inside PP3i)			x		
E2840-E2841	Input power unstable			x		
E2842, E2853	Line phase missing, mains supply to Pentpak			x		
E2851, E2853	Under voltage, mains supply to Pentpak			x		
E2852, E2854	Under voltage, mains supply to Pentpak			x		
E2861-E2864	Overvoltage, mains supply to Pentpak			x		
E2897	CAN TX errors, communication inside PP3i			x		
E2898	Unsupported software version				x	
E2899	No communication with Rectifier inside PP3i			x		

There are more Error codes which can occur. Contact your Pentrunder authorized service workshop for information.

*Not applicable in markets outside of Europe. Contact your Pentrunder authorized service workshop for information.

5.3 Menu functions

5.3.1 Navigating the menu

1. Press the Menu button to open the menu. This can be done during cutting.
2. Move the “marker” using the + and – buttons to the menu item you want to choose and press the Enter button.
3. To return to the cutting display, move the “marker” to the arrow symbol and press the Enter button.

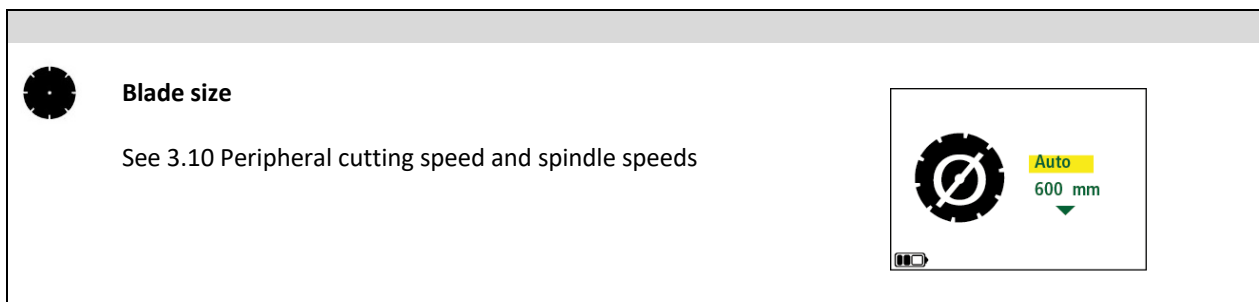
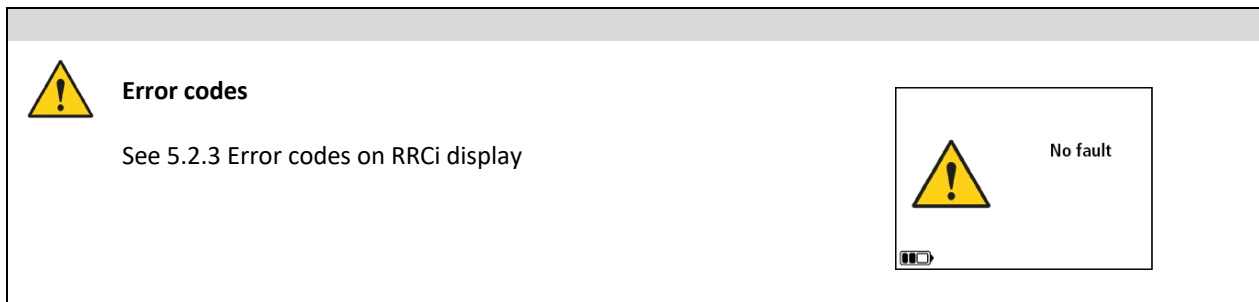
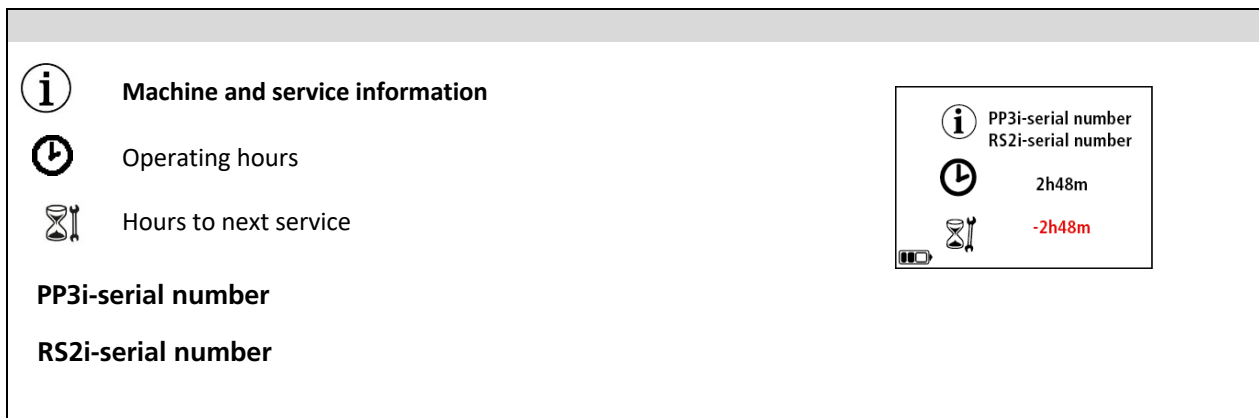
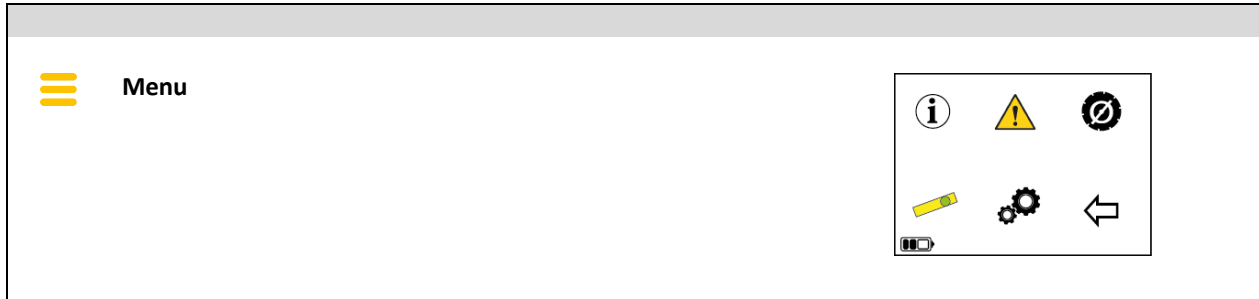

 **Level**

This display shows the angle of the saw head in two axis.

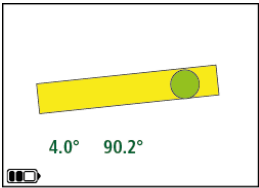

 **Settings**

Choose between metric/imperial. Press Enter to store.

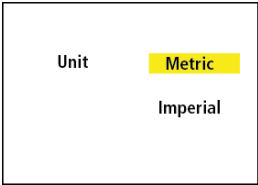

 **Return**

Enter button. Choose to return to the cutting display.

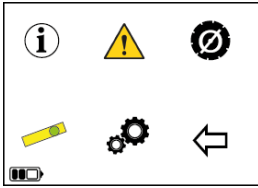

6 Maintenance



WARNING!



No service or maintenance may be performed on the machine unless it is disconnected electrically from the mains.

For the machine to remain in a condition which is always safe for operation, maintenance is needed.

The maintenance in chapter 6.1 Every day / week maintenance should be performed by the operator or a service technician.

The machine should be serviced by a Pentruder authorized technician every 80 running hours. The service indicator on RRC display.

6.1 Every day / week maintenance

6.1.1 Clean the machine, grease and lubricate, and check all functions

The machine should be carefully cleaned, and all functions checked and found normal before use of the machine. If a high-pressure washer is used, the nozzle may NOT be pointed at any of the rotating parts or connectors on the machine.



Important!

Tractive recommends using a water hose with a brush. Leave the cable connected or use covers on the electrical connectors to prevent water and dirt to get into the connectors.

Parts on the machine which require extra attention

- 6.1.2 Blade flange and center screws/bolts for flush cutting flange
- 6.1.3 Quick disconnect coupling for blade
- 6.1.4 Track rollers
- 6.1.5 Eccentric locking mechanism for handles
- 6.1.6 Cables and connectors
- 6.1.7 Remote controls
- 6.1.8 Arm transmission
- 6.1.9 Water filter on Pentpak 3i
- 6.1.10 Transport trolley

6.1.2 Blade flange and center screws/bolts for flush cutting flange

Threads on the center screw and the female thread on the blade flange:

- Make sure all parts are undamaged and not corroded
- Clean with a brass brush
- Lubricate with grease

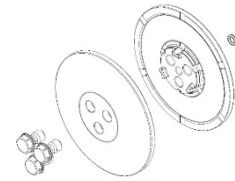

Friction surfaces of flange and blade must be

- Dry and free from grease and dirt. If not, they cannot securely transmit the torque of the saw blade motor without slippage. Slippage will cause irreparable damage to the flanges.

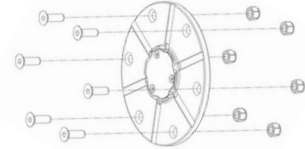

6.1.3 Quick disconnect coupling for blade

Drive dogs and centering cone on quick disconnect coupling:

- Make sure all parts are undamaged and not corroded
- Clean with a brass brush

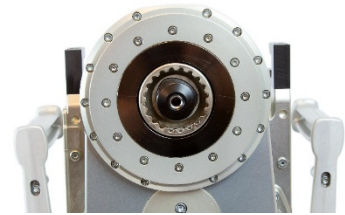

WARNING!

- Corrosion of the threads or any part mentioned above may cause failure of the bolt which can result in serious injury and even to fatal injuries to persons in close proximity of the machine.
- Always keep all parts of the coupling clean and lubricated! The safe operation of the coupling depends on cleanliness of all coupling parts on the machine, and the blade flange!
- Always replace worn, corroded or damaged bolts for the flush cutting flange with new of correct length and quality, M8 x 25 10.9 or M10 x 25 10.9

6.1.4 Track rollers

- Adjust the track rollers correctly on the track. Use a 6 mm allen key for loosening the locking screw, use another 6 mm allen key from the track roller side to adjust the lower eccentric shafts on which the rollers are fitted, until tight. There should be a little resistance when turning the handles to lock the saw on the track.
- Check that the track rollers on the saw head can move freely without too much friction. A certain amount of friction is always present as the bearings are double sealed with both rubber and steel scraper seals.

Contact your Pentruder distributor or service center for replacing bearings and steel scraper seals when worn or if the rollers don't run freely.

6 mm allen key

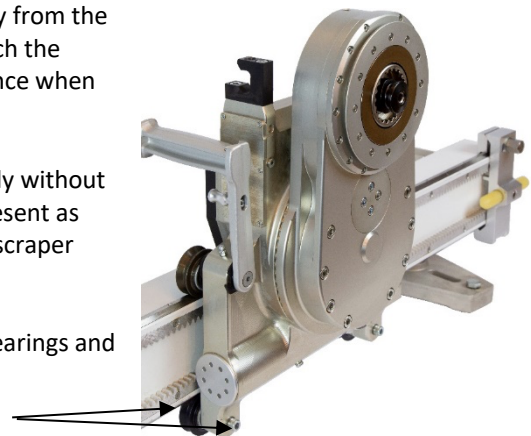

6.1.5 Eccentric locking mechanism for handles

If necessary, grease the eccentric locking mechanism for the handles.

6.1.6 Cables and connectors

Check that the machine cable and connectors are undamaged and in faultless condition.

Make sure the connectors are clean and dry. Do not lubricate the pins and sockets since that will attract more dirt compared to a clean and dry one.

6.1.7 Remote control

Check the remote control for correct function.

6.1.8 Arm transmission

Check the condition of the gearbox oil (arm transmission) every week. To check, clean thoroughly around the plug and blow with compressed air before the plug is removed. If dirt is allowed to enter, the gearbox may seize and the warranty is not valid.

If the oil seems to contain water, it needs to be replaced. Please contact your Pentruder authorized workshop for service.

6.1.9 Water filter on Pentpak 3i

The Pentpak 3i is equipped with a built in water filter. Depending on the water quality the water filter should be checked every week. Also check it if the water flow is lower than normal.

- a. Take apart the filter, using a 19 mm wrench.
- b. Check the condition of the filter and replace if damaged.
- c. Clean the filter if it is in ok condition and reassemble.

6.1.10 Transport trolley

The maintenance instructions for the other parts of the wall saw also apply when they are to be mounted on the trolley. Always check the overall condition of the trolley and tire pressure before use and clean when needed with water and brush to make sure all parts can be mounted safely without damaging the equipment. Tighten screws and nuts on the trolley if necessary. Please contact your Pentruder authorized workshop for help and spare parts.



Important!

- You may not replace the lifting eyelets on your own initiative, and they must always be positioned correctly (see 3.2.1)
 - Do not use the trolley if any of its load-bearing parts have been damaged/ deformed or show signs of corrosion, this especially applies to the lifting eyelets if they are to be used.
 - The trolley must not be used if the pre-mounted plastic plugs on its sides are damaged or missing.
 - Do not use a high-pressure washer to clean the trolley.
-

7 Technical data

Pentruder RS2i HFi wall saw	RS2i
Max blade \varnothing :	1600 mm
Blade capacity \varnothing :	600 – 1600 mm
Max. cutting depth:	715 mm
Max. blade starting diameter, \varnothing :	830 mm
Spindle speed, rpm:	560 – 1125 rpm
Max output torque:	148 Nm
Blade motor max continuous power:	18 kW
Max travel speed:	2.6 m/min
Max arm rotation speed:	2.4 rpm/min
Weight, including blade motor:	24.5 kg
Protection class:	IP65

HF-power pack	Pentpak 3i used with RS2i
Input voltage:	380 – 480 V 3-phase supply with PE
Input frequency:	50 – 60 Hz
Minimum fuse*:	16 Ampere
Recommended fuse:	32 Ampere
Current draw at max. output:	31 Ampere
Recommended generator size:	45 kVA
Contains:	IC: 8595A-N INAB30 FCC ID: XPYNINAB30
Height incl. handles, connectors:	180 mm
Width incl. handles, connectors:	300 mm
Length:	400 mm
Weight:	13.5 kg
Water cooling:	6 liters of cool water per minute (4 C° - 30 C°) min 1 bar – max 6 bar
Protection class:	IP64

* The power output must be reduced to about 65% by turning the feed and power regulation knob down. See amperage draw on RRC display.

Radio remote control (RRCi)	
Weight:	1.8 kg
Contains:	IC: 8154A-IW05 FCC ID: S7A-IW05
Protection class:	IP65

Transport trolley	
Weight:	35 kg
Length x width x height (unloaded):	980 x 690 x 1170 mm (approx.)
Max permissible total weight:	170 kg
Weight loaded with complete machine:	130 kg (approx.)

Noise emission	Sound power level ¹	Sound pressure level ² :
Pentruder RS2i wall saw	112 dB(A)	95 dB(A)

- 1) Noise emissions in the environment measured as sound power (L_{WA}) in conformity with EN 15027/A1. Measured in accordance with EN ISO 3744:1995.
- 2) Noise pressure level according to EN 15027/A1. Reported data for noise pressure level has a typical statistical dispersion (standard deviation) of 1.0 dB(A). Measured in accordance with EN ISO 11201:1995.

Declaration of Conformity

According to the Machinery Directive 2006/42/EC, annex A1

The Manufacturer: Tractive AB
Gjutargatan 54
78170 Borlänge
Sweden

Person authorized to compile the technical file:
Anders Johnsen
Gjutargatan 54
78170 Borlänge
Sweden

Hereby declare that the machine:

Category: Wall saw
Make: Pentrunder
Type: RS2i
Drive system: HFi power pack
Type: Pentpak 3i
Accessories: As stated in this Operator's manual.

Is in conformity with the provisions of the Machinery Directive 2006/42/EC.

Is in conformity with the provisions of the following other EC-directives:

- Low Voltage Directive 2014/35/EU
- Electromagnetic Compatibility Directive 2014/30/EU
- Radio Equipment Directive 2014/53/EU

In accordance with the EC-declaration of conformity, the product must not be modified without the manufacturer's permission. If this occurs, this documented EC-declaration ceases to apply and the modifier is considered to be the manufacturer and must verify and draw up an addendum to the EC-declaration and file technical data for the inspection authority.

Borlänge 1st of March 2021



Anders Johnsen

Technical Director